

Foreword

The V6-H series inverter is a kind of high-performance vector control/torque control inverter provided by V&T Technologies Co., Ltd.

The product adopts speed sensorless vector control technology and torque control technology, the internationally leading technology, to offer excellent control performance and combines the application characteristics of China to further enhance the product reliability, environment adaptability and customized and industrialized design. It can better meet the demands of the various drive applications.

Excellent Performance

■ Control Mode

◆ Vector Control 1:

Offering excellent vector control performance and insensitive to motor parameters.

Startup torque: 0.50Hz 180% rated torque

Speed adjustment range: 1:100

Speed stabilization precision: $\pm 0.5\%$

0.50Hz controllable motor stable operation with 150% rated torque

◆ Vector Control 2 (Without Encoder Speed Feedback):

Precise speed sensorless vector control technology realizes AC motor decoupling, enabling the DC motorization of operation control.

Startup torque: 0.25Hz 180% rated torque

Speed adjustment range: 1:200

Speed stabilization precision: $\pm 0.2\%$

0.25Hz controllable motor stable operation with 150% rated torque

◆ Vector Control 2 (With Encoder Speed Feedback):

Startup torque: 0.00Hz 180% rated torque

Speed adjustment range: 1:1000

Speed stabilization precision: $\pm 0.02\%$

◆ Open Loop Torque Control Mode:

Independent current loop control to realize true torque control, supporting online switching of torque control and speed control.

Torque precision: $\pm 5\%$

Torque response time: <20ms

◆ Closed Loop Torque Control Mode:

Independent current loop control to realize true torque control, supporting online switching of torque control and speed control.

Torque precision: $\pm 5\%$

Torque response time: <10ms

■ Excellent Control Performance under Speed Sensorless Vector Control Mode

- ◆ Realizing AC motor decoupling, enabling the DC motorization of operation control.
- ◆ Fig. 1 indicates the four-quadrant operation of the motor under speed sensorless vector control. The torque, current, speed and DC bus voltage have quick response, and the motor has stable operation.
- ◆ Realizing 0.1s acceleration/deceleration with rated motor load.
- ◆ Upon the zero-crossing switching of the motor (forward/reverse switching), the current

has no phase mutation or oscillation, and the rotating speed has no pulsation.

- ◆ The bus voltage is under stable control. Quick and reliable braking can be realized when decelerating under the condition of braking without power consumption.

It is especially suitable for:

The reciprocating equipment, such as numerical control machine, fountain control machine, weaving machine and jacquard.

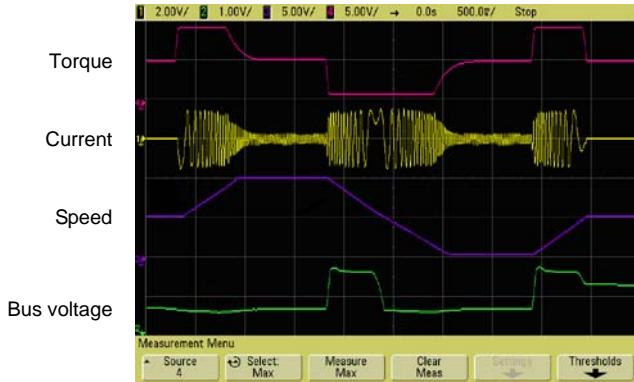

Fig. 1 Quick acceleration/deceleration four-quadrant running in the form of 0Hz

→ Forward running 50Hz→0Hz→ Reverse running 50Hz→0Hz

■ Realizing Real Tripless Operation

- ◆ With excellent current and voltage control technology, 0.1s repetitive and alternate acceleration and deceleration is performed, and the inverter realizes stable and tripless operation.
- ◆ With extremely powerful loading capability, the inverter can realize stable tripless operation in any acceleration/deceleration time and under any impact load condition.
- ◆ With strong short-time overload capability, the inverter can operate continuously for 0.5s under 200% rated load, and 1 minute under 150% rated load.
- ◆ The intelligent module temperature control maximizes the loading capability of the inverter.

It is especially suitable for:

The heavy-duty equipment, such as injection molding machine (modification for energy saving), lifting equipment, numerical control machine, rolling mill, furnace feeding equipment.

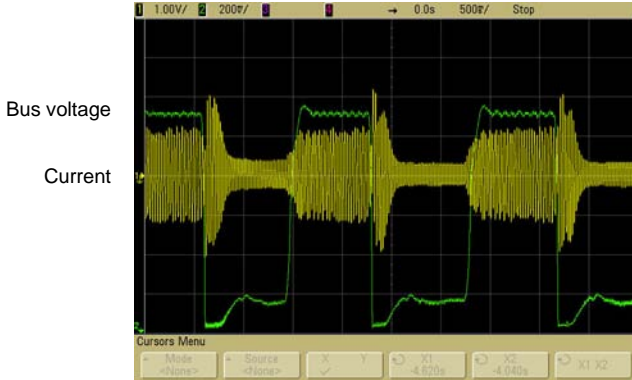

Fig. 2 The inverter realizes stable control of current and voltage and will not trigger under any acceleration/deceleration condition as well as stable operation condition

■ Large Torque and Stable Operation at Low Frequency under Vector Control

- ◆ With precise speed identification and rotor magnetic flux orientation, the torque responds quickly and stable operation in the case of 0.25Hz load mutation.
- ◆ Startup torque: Vector control 2 without encoder speed feedback: 0.25Hz; 180% rated torque
Vector control 2 with encoder speed feedback: 0.00Hz; 180% rated torque
- ◆ Speed stabilization precision: Vector control 2 without encoder speed feedback: $\pm 0.2\%$
Vector control 2 with encoder speed feedback: $\pm 0.02\%$

It is especially suitable for:

Medium and large wire-drawing machine, pipe and cable processing, lifting equipment, rolling mill.

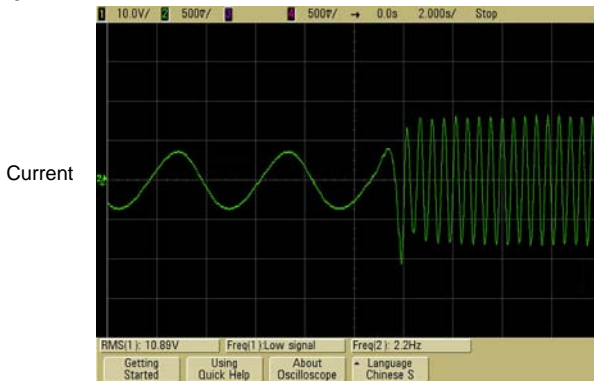

Fig.3 Abrupt increase to full load operation at 0.25Hz under speed sensorless vector control

■ Unique Instantaneous Mains Failure Reaction

- ◆ Upon the instantaneous mains failure, the energy of the motor feedback bus will keep the inverter running till the mains resumes normal.
- ◆ When shutdown is caused by long-term power-failure during the operation of the inverter, the inverter will provide alarm message after power resumes normal.
- ◆ It supports the automatic operation after power-up.
- ◆ The deceleration time during the power failure and the acceleration time after the power recovery can be set independently.

It is especially suitable for:

Instantaneous power-failure startup equipment, such as chemical fiber and weaving equipment, multi-point synchronization linkage equipment, fan/pump, etc.

■ Torque Control Operation

- ◆ Independent current loop control to realize true torque control.
- ◆ Supporting online switching of torque control and speed control.
- ◆ Digital reference or analog reference can be selected for torque reference.
- ◆ Open loop torque control mode Torque precision: $\pm 5\%$; Torque response: $< 20\text{ms}$
- ◆ Closed loop torque control mode Torque precision: $\pm 5\%$; Torque response: $< 10\text{ms}$

It is especially suitable for:

Winding/unwinding equipment, multi-point driver, rolling mills, printing machine and packaging machine.

■ Unique Speed Tracing Function

- ◆ It doesn't need special hardware detection circuit and no special function code to be set. Within the range of 0 to 60Hz, the inverter can complete identification the motor rotating speed, rotating direction and phase angle within 0.2s, and start smooth tracing on the freely rotating motor.
- ◆ Tracing mode 1: Quick and smooth tracing on the free speed motor without any impact.

It is especially suitable for:

The equipment whose operation shall be traced upon the power recovery after instantaneous power failure, such as fan and pump.

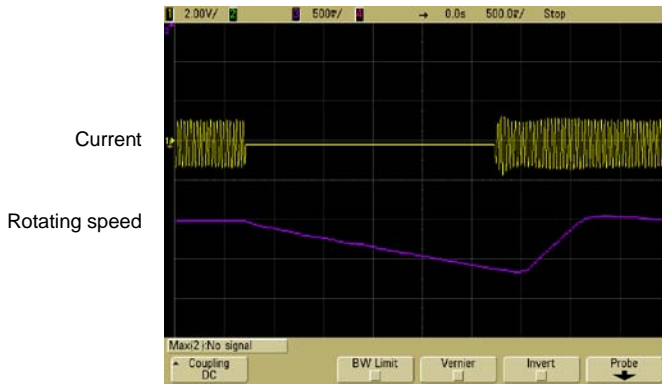

Fig. 4 Quick and impactless rotating speed tracing upon the motor free rotation

- ◆ Tracing mode 2: Impactlessly pull down the motor from high-speed to low speed and then accelerate to normal speed.

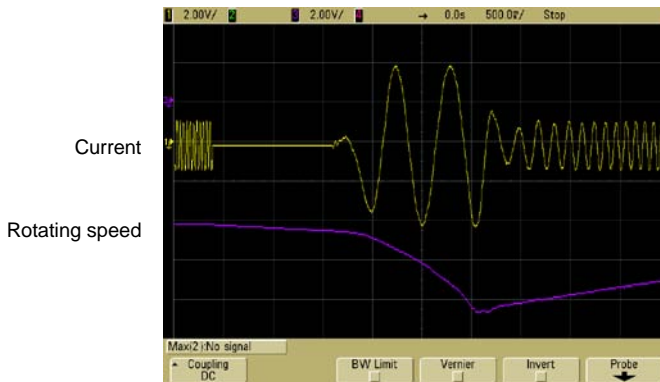

Fig. 5 Tracing and smooth startup after frequency reduction upon the motor high-speed free rotation

■ Unique Quick DC Braking

- ◆ Within the range of 0 to 300Hz, the inverter can realize back electromotive force elimination and quick DC braking within 0.3s.
- ◆ DC current input in the most efficient way to improve the braking capability.
- ◆ There is no initial waiting time for the DC braking.
- ◆ Special function code of the initial waiting time for DC braking setting is cancelled.

It is especially suitable for:

Lifting equipment, invertible roll table for rolling mill, weaving machine, paper making production line.

High Reliability Design

■ Meeting the Relevant International Product Standards

IEC61800-2	General requirements–Rating specifications for low voltage adjustable frequency a.c. power drive systems
IEC61800-3	EMC product standard including specific test methods
IEC61000-6	Electromagnetic compatibility (EMC) –Part6: Generic standards
IEC61800-5-1	Safety requirements –Electrical, thermal and energy
UL508C	UL Standard for Safety for Power Conversion Equipment

■ Integrated Design

- ◆ Integrated design of hardware interface: The control board, button/shuttle type operation panel are integrated to facilitate the operation and maintenance of the user.
- ◆ Integrated design of software protocol: Terminal/operation panel 485, universal expansion port SPI protocols are integrated (Modbus protocol).
- ◆ Integrated design of main circuit terminals: 0.75G to 15G integrated, 18.5G to 75G integrated, 90G to 500G integrated, to facilitate the operation and maintenance of the user.
- ◆ Built-in braking unit design: 0.75G to 15G as standard, 18.5G to 75G as option, to reduce the cost and the installation space.
- ◆ Integrated built-in expansion card design: including injection molding machine interface card/PG feedback card/communication adapter card, meeting the industry application requirement.
- ◆ Full series standard common DC bus design: The standard common DC bus scheme can be realized without modifying the product or adding peripheral circuit. It is applicable to such industry applications as paper making, chemical fiber, metallurgy and EPS.

■ Adaptability Design

- ◆ Independent duct design: The full series supports the application demand of mounting heatsink out of the cabinet, and is applicable to the applications of spinning machine, wire-drawing machine where there is too much cotton batting or dust.
- ◆ Compact structure design: With complete thermal emulation and unique cold plate process, the product has compact structure, meeting the demands of OEM customers.
- ◆ Complete system protection design: Based on the complete system design scheme, the PCB adopts protective coating, the copper bus adopts galvanization, the full series of product adopts sealed key components, the button and shuttle type operation panels can offer accessories meeting the IP54 requirement, which greatly

improve the protection capability of the system. It is applicable to the applications with dusty and corrosive environment, such as wire-drawing machine, printing and dyeing and ceramics.

- ◆ Wide voltage range design: the DC operating voltage range is DC 360~720V, with mains voltage fluctuation recording function.
- ◆ Precise current detection and protection: The full series adopts precise Hall sensor to detect the output current, meeting the quick real time control and protection requirement of software and hardware, ensuring the performance and reliability of the system.
- ◆ Independent power supply for control: The system provides independent switching power DC input port. External UPS power supply can be realized through option card. It is applicable to the applications of oilfield, chemical industry and printing and dyeing industry.
- ◆ Power-up self-detection function: It realizes the power-up detection on the peripheral circuit, such as motor grounding, disconnection, greatly improving the reliability of the system.
- ◆ Comprehensive system protection function: software/hardware current limiting protection, overcurrent and overvoltage protection, grounding short circuit protection, overload protection, IGBT short circuit protection, abnormal current detection protection, abnormal relay contact protection.
- ◆ Perfect terminal protection function: short circuit and overload protection for the +24V and +10V power supply of the control terminal, operation panel cable reverse connection protection, input signal cable disconnection and abnormal analog input protection.
- ◆ Over-temperature prealarm protection function: Automatic adjustment will be made according to the temperature to ensure the reliable operation of the product, and maximum operating temperature will be recorded.
- ◆ Comprehensive switching power protection function: including switching power output short circuit protection, overload protection, power-up walk-in function, open loop self-locking and voltage limiting protection function, ensuring the reliability of the system.

Rich and Flexible Functions

■ Multiple Frequency Reference Modes, Flexible and Convenient for Operation

- ◆ Operation panel reference (digital reference). The operation panel can be used to conduct V/\wedge adjustment on the frequency reference.
- ◆ Terminal reference:
 - 1) Analog AI1/AI2: 0 to 10V or 0 to 20mA
 - 2) Analog AI3: -10V to 10V
 - 3) Pulse frequency X7/DI: 0.2Hz to 50kHz
 - 4) Xi terminal: UP/DN mode independent, able to superpose with any other frequency reference mode
- ◆ Communication mode reference: International standard Modbus protocol.
- ◆ The above reference modes can be switched online.

■ Multiple Channels for Reference and Feedback

- ◆ Under the open loop mode and analog feedback close loop mode, the reference value can define the main and auxiliary calculation relation:
 - 1) Main reference + auxiliary reference
 - 2) Main reference - auxiliary reference
 - 3) Main reference + auxiliary reference -50%
 - 4) Max (main reference, auxiliary reference)
 - 5) Min (main reference, auxiliary reference)
- ◆ The sign of the main and auxiliary reference calculation (positive or negative) can automatically determine the rotation direction of the motor.
- ◆ Under the analog feedback close loop mode, the feedback value can also define the main and auxiliary calculation relation before it enters the process PID for adjustment control.

It is especially suitable for:

The continuous and automatic production lines, such as paper making, printing and dyeing, packaging and printing.

The temperature difference and pressure difference applications, such as the chilled water control of the central air conditioner, the water supply system.

■ Digital Operation Panel

- ◆ Button type and shuttle type selectable, RS485 communication mode, standard network port connection.
- ◆ The button layout complies with the human engineering principle. One-button function code access and exit, making it easy for the operation.
- ◆ The standard configuration operation panel can realize parameter copy and remote control function (maximum length: 500m).

- ◆ With unique multifunctional button **M**, the following functions can be defined:
 - 1) JOG
 - 2) Emergency shutdown 1 (fastest shutdown)
 - 3) Emergency shutdown 2 (free shutdown)
 - 4) Reference mode switch through operating command (operation panel reference → terminal reference → host computer reference → operation panel reference)
 - 5) FASt/bASE menu switch; ndFt/bASE menu switch; LAST/bASE menu switch
 - 6) Menu mode switching (bASE → FASt → ndFt → LAST → bASE)

■ Host Computer Communication

- ◆ The operation panel and terminals provide 485 ports, the communication protocol is Modbus, and host computer monitoring software is provided.
- ◆ Master slave communication control among several inverters can be realized.
- ◆ Parameter upload and download can be realized.
- ◆ Cascade transmission of operating frequencies for several inverters can be realized to provide digital frequency divider functions.

Customized Functions

■ Multiple Function Code Display Modes

- ◆ bASE: Basic menu mode (refer to 5.1 basic menu function code parameter table), displays all the function codes.
- ◆ FASt: Fast menu mode, is especially suitable for the naive users.
- ◆ ndFt: Non-leave-factory value menu mode, it only displays the function codes different from the leave-factory values to facilitate the inquiry and commissioning.
- ◆ LAsT: Last change menu mode, it displays the 10 functions codes that are recently changed and P0.02 to facilitate the inquiry and commissioning.
- ◆ The users can define the function codes for inquiry and modification by themselves.

■ Multiple Function Code Encryption Modes (to Protect the Intellectual Property of the Customers)

- ◆ The user can encrypt any group function codes by themselves.
- ◆ The user can lock operation panel.
- ◆ The user can set function parameter password protection.
- ◆ The technical secrets, such as system specific process parameters, cannot be copied.

■ User Self-defined Parameter Display Function

- ◆ The user can choose the common parameters displayed by the operation panel and use to >> key switch such parameters.
- ◆ The user can define the parameters displayed upon running and stopping respectively.
- ◆ The user can define such parameters as pressure, temperature, flux and line speed.

■ The User can Make Secondary Development

- ◆ Universal expansion port is provided as standard.
- ◆ Physical port SPI bus, software protocol Modbus.
- ◆ The ports provide +24V, ±15V and 5V power supply and two ways of A/D input.
- ◆ The CPU expansion scheme can realize PLC function.
- ◆ It supports the programming by user to realize process control.

■ Enhanced Function

- ◆ The software filtering time for the AI1, AI2 and AI3 analog input is settable to enhance the anti-interference capability.
- ◆ Independent multi-section modification can be made on the AI1, AI2, AI3 and DI analog input curve.
- ◆ Multi-section speed setting is provided, with 16 speeds as standard, and up to 23 speeds.
- ◆ With a maximum output frequency of 3000Hz, it is applicable to such equipment as

vacuum pump, grinding machine, female thread extrusion machine.

- ◆ With the acceleration/deceleration time up to 10 hours, it is applicable to the bobbiner and other equipment of the textile industry.
- ◆ It supports the overload protection with motor temperature feedback.
- ◆ Customized timed shutdown, with the duration up to 100 hours.
- ◆ The user can select button type or shuttle type operation panel according to their preference.
- ◆ Independent high-speed pulse input and output ports are provided to realize high-speed pulse cascade function.

Typical industry applications

■ **Closed Control of Machine Mainshaft**

- ◆ Perfect inverter zero-servo features under vector control 2 with encoder speed feedback.
- ◆ Providing multi-point positioning under any positioning angle setting
- ◆ Large torque at low-frequency: 180% rated torque can be output at 0Hz under motoring status to satisfy the low-speed heavy-duty cutting process requirement of machine mainshaft.
- ◆ High steady speed precision: The steady speed precision is 0.02% of the rated rotation speed, with small speed fluctuation.
- ◆ Reliable operation control: Built-in torque limiting and over-voltage adjustment greatly reduce the chance of tripping action.
- ◆ Quick dynamic response: The response time for dynamic torque: <10ms, realizing small speed fluctuation upon abrupt loading/unloading during the cutting process.
- ◆ Perfect four-quadrant control technology supporting 0.1s acceleration/deceleration forward/reverse running operation.

■ **Special Function for Wire-drawing Machine**

- ◆ High-performance vector control/torque control inverter provides various drawing and winding/unwinding applications.
- ◆ The speed solution and torque solution can adapt to different requirements of wire-drawing machines to the greatest extent.
- ◆ The domestically pioneering torque control with speed sensorless feedback is able to realize the switching between torque motor and magnetic braking/clutch.
- ◆ The products are embedded with roll diameter calculation and PID adjuster to realize constant tension control for the wires.
- ◆ Multiple winding/unwinding solutions are provided to realize the operation under the condition that there is no tension feedback or speed feedback signal.

■ **Constant Tension Control System**

- ◆ Able to realize open loop torque control without encoder speed feedback, eliminating the trouble of encoder maintenance.
- ◆ Able to replace the torque motor in extensive applications, reduce power consumption and prolong use life of equipment without changing the original operation practices.
- ◆ Providing steady speed precision of up to 0.02% with speed encoder feedback to ensure constant line speed.
- ◆ Torque output precision: 5%, response time: less than 10ms, the excellent torque control performance can ensure stable and precise tension for materials.
- ◆ Built-in roll diameter calculation function and tension control compensation algorithm

to simply the PLC program design and facilitate the applications

- ◆ Providing mature and efficient PID control algorithm, including PID limiting, PID cancellation and PID auto-adaptation.
- ◆ Providing many useful functions, such as material breaking detection and alarm, material breaking control losing protection, meter counter and line speed meter.

■ Injection Moulding Machine Energy Saving

- ◆ Powerful abrupt acceleration/deceleration adjustment capability, it takes only 0.1 second for the motor to start from stop status to rated rotating speed.
- ◆ Perfect separate duct design, the rear parts and top fans are convenient for removal and maintenance; dust proof, corrosion proof and strong environment adaptability, high IP rating.
- ◆ Adopting advanced DSP chip and excellent vector control to match the molding machine power with the output power of integrated cabinet.
- ◆ The inverter can realize stable triplex operation in any acceleration/deceleration time and under any impact load condition.
- ◆ The user does not need to change the inverter parameter when replacing the moulds. The process curve memory can be easily realized.
- ◆ Wide range torque output: Within the set range of pressure and flow, the motor torque output is stable to ensure the quality of the workpiece.
- ◆ Green output: It adopts advanced power module drive mode to reduce the interference to the moulding machine control circuit and sensor.

Safety Precautions

Description of safety marks:



Danger: The misuse may cause fire, severe injury, even death.



Note: The misuse may cause medium or minor injury and equipment damage.

■ Use



- This series of inverter is used to control the variable speed operation of three-phase motor and cannot be used for single-phase motor or other applications. Otherwise, inverter failure or fire may be caused.
- This series of inverter cannot be simply used in the applications directly related to the human safety, such as the medical equipment.
- This series of inverter is produced under strict quality management system. If the inverter failure may cause severe accident or loss, safety measures, such as redundancy or bypass, shall be taken.

■ Goods Arrival Inspection



- If the inverter is found to be damaged or lack parts, the inverter cannot be installed. Otherwise, accident may be caused.

■ Installation



- When handling and installing the product, please hold the product bottom. Do not hold the enclosure only. Otherwise, your feet may be injured and the inverter may be damaged because of dropping.
- The inverter shall be mounted on the fire retardant surface, such as metal, and kept far away from the inflammables and heat source.
- Keep the drilling scraps from falling into the inside of the inverter during the installation; otherwise, inverter failure may be caused.
- When the inverter is installed inside the cabinet, the electricity control cabinet shall be equipped with fan and ventilation port. And ducts for radiation shall be constructed in the cabinet.

■ Wiring



- The wiring must be conducted by qualified electricians. Otherwise, there exists the risk of electric shock or inverter damage.
- Before wiring, confirm that the power supply is disconnected. Otherwise, there exists the risk of electric shock or fire.
- The grounding terminal PE must be reliably grounded, otherwise, the inverter enclosure may become live.
- Please do not touch the main circuit terminal. The wires of the inverter main circuit terminals must not contact the enclosure. Otherwise, there exists the risk of electric shock.
- The connecting terminals for the braking resistor are \ominus 2/B1 and B2. Please do not connect terminals other than these two. Otherwise, fire may be caused.
- The leakage current of the inverter system is more than 3.5mA, and the specific value of the leakage current is determined by the use conditions. To ensure the safety, the inverter and the motor must be grounded.

■ Wiring



- The three-phase power supply cannot connect to output terminals U/T1, V/T2 and W/T3, otherwise, the inverter will be damaged.
- It is forbidden to connect the output terminal of the inverter to the capacitor or LC/RC noise filter with phase lead, otherwise, the internal components of the inverter may be damaged.
- Please confirm that the power supply phases, rated voltage are consistent with that of the nameplate, otherwise, the inverter may be damaged.
- Do not perform dielectric strength test on the inverter, otherwise, the inverter may be damaged.
- The wires of the main circuit terminals and the wires of the control circuit terminals shall be laid separately or in a square-crossing mode, otherwise, the control signal may be interfered.
- The wires of the main circuit terminals shall adopt lugs with insulating sleeves.
- The inverter input and output cables with proper sectional area shall be selected according to the inverter power.
- When the length of the cables between the inverter and the motor is more than 100m, it is suggested to use output reactor to avoid the inverter failure caused by the overcurrent of the distribution capacitor.
- The inverter which equipped with DC reactor must connect with DC reactor between the terminal of \oplus 1、 \oplus 2, otherwise the inverter will not display after power on.

■ Operation



- Power supply can only be connected after the wiring is completed and the cover is installed. It is forbidden to remove the cover in live condition; otherwise, there exists the risk of electric shock.
- When auto failure reset function or restart function is set, isolation measures shall be taken for the mechanical equipment, otherwise, personal injury may be caused.
- When the inverter is powered on, even when it is in the stop state, the terminals of the inverter are still live. Do not touch the inverter terminals; otherwise electric shock may be caused.
- The failure and alarm signal can only be reset after the running command has been cut off. Otherwise, personal injury may be caused.



- Do not start or shut down the inverter by switching on or off the power supply, otherwise, the inverter may be damaged.
- Before operation, please confirm if the motor and equipment are in the allowable use range, otherwise, the equipment may be damaged.
- The heatsink and the braking resistor have high temperature. Please do not touch such device; otherwise, you may be burnt.
- When it is used on lifting equipment, mechanical contracting brake shall also be equipped.
- Please do not change the inverter parameter randomly. Most of the factory set parameters of the inverter can meet the operating requirement, and the user only needs to set some necessary parameters. Any random change of the parameter may cause the damage of the mechanical equipment.
- In the applications with industrial frequency and variable frequency switching, the two contactors for controlling the industrial frequency and variable frequency switching shall be interlocked.

■ Maintenance, Inspection



- In the power-on state, please do not touch the inverter terminals; otherwise, there exists the risk of electric shock.
- If cover is to be removed, the power supply must be disconnected first.
- Wait for at least 10 minutes after power off or confirm that the CHARGE LED is off before maintenance and inspection to prevent the harm caused by the residual voltage of the main circuit electrolytic capacitor to persons.
- The components shall be maintained, inspected or replaced by qualified electricians.



- The circuit boards have large scale CMOS IC. Please do not touch the board to avoid the circuit board damage caused by electro static.

■ Others



- It is forbidden to modify the inverter unauthorizedly; otherwise, personal injury may be caused.

Contents

Chapter 1 Introduction to V6-H Series Inverter	1
1.1 Product Model Description.....	1
1.2 Product Nameplate Description	1
1.3 Product Series.....	2
1.4 Technical Specifications of Product.....	4
1.5 Product Component Name	6
1.6 Product Outline, Mounting Dimension, and Weight	6
1.7 Operation Panel Outline and Mounting Dimension	8
1.8 Pallet Outline and Mounting Dimension	9
1.9 Braking Resistor Lectotype.....	10
Chapter 2 Inverter Installation	11
2.1 Environment for Product Installation	11
2.2 Mounting Direction and Space	11
2.3 Removal and Mounting of Operation Panel and Cover.....	12
Chapter 3 Wiring of Inverter	16
3.1 Connection of the Product and Peripheral Devices	16
3.2 Description of Peripheral Devices for Main Circuit.....	17
3.3 Lectotype of Main Circuit Peripheral Devices	17
3.4 Product Terminal Configuration.....	17
3.5 Functions of Main Circuit Terminal	19
3.6 Attention for Main Circuit Wiring.....	20
3.7 Terminal Wiring	23
3.8 Functions of Control Circuit Terminals.....	24
3.9 Schematic Diagram of Control Board.....	28
3.10 Lectotype of Control Circuit Peripheral Devices	28
3.11 Description of Jumper Function.....	28
Chapter 4 Using Instructions of Operation Panel	29
4.1 Introduction to Operation Panel	29
4.2 Descriptions of Indicators	29
4.3 Description of Keys on Operation Panel.....	30
4.4 Menu Style	32
4.5 Password Operation.....	36
4.6 Lock/Unlock Keys.....	37
4.7 Operation Panel Display and Key Operation.....	38
4.8 Operation Example.....	39
4.9 Running for the First Time	40
Chapter 5 List of Parameters	42
5.1 List of Basic Menu Function Codes.....	42
5.2 User's Prameter Record	60
5.3 User's Connection Diagram.....	61
Chapter 6 Parameter Description	62
6.1 Basic Function Parameters (Group P0)	62
6.2 Main and Auxiliary Reference Parameters (Group P1)	67

6.3 Key and Display Parameters (Group P2)	71
6.4 Startup/stop Parameters (Group P3).....	74
6.5 Multi-section Parameters (Group P4).....	76
6.6 Multi-functional Input Parameters (Group P5)	79
6.7 Analog Reference Parameters (Group P6).....	87
6.8 Multi-function Output Parameters (Group P7)	91
6.9 Process PID Close Loop Parameters (Group P8)	97
6.10 Motor Parameters (Group P9)	99
6.11 Control Parameters (Group PA)	103
6.12 Enhanced Function Parameters (Group Pb)	109
6.13 Communication Parameters (Group PC).....	113
6.14 Vector Control 2 Parameters (Group Pd)	114
6.15 Failure Record Parameters (Group d0).....	120
6.16 Product Identity Parameters (Group d1).....	121
6.17 Use of Display Parameters (Group d2)	122
6.18 User-defined Function Code Display/hidden Zone Parameters (Group d2).....	122
Chapter 7 Fault Diagnosis.....	124
7.1 List of Fault and Alarm Information	124
7.2 Troubleshooting Procedures.....	130
Chapter 8 Routine Repair and Maintenance.....	131
8.1 Routine Maintenance	131
8.2 Periodic Maintenance.....	132
8.3 Component Replacement.....	132
8.4 Insulation Test	132
Appendix A Modbus Communication Protocol.....	134
1. Support Protocol	134
2. Interface Mode	134
3. Protocol Format.....	134
4. Function Interpretation.....	135
5. Inverter Register Address Distribution.....	137
6. CRC16 Function.....	140
7. Case Study of Modbus Communication Control.....	140
8. Communication Network Construction.....	141
Appendix B Control Mode Setting Process.....	142
1. Setting Process for Auto-tuning.....	142
2. Setting Process for Open Loop.....	142
3. Setting Process for Closed Loop	145
4. Setting Process for Torque Control	147
5. Setting Process for Composite Control	149
Appendix C FAQ	149
Appendix D PG Card Lectotype and Connection Diagram	153
1. Option Introduction.....	153
2. Frequency Division Number Setting of PG Card	153
3. PG Card Lectotype and Connection Diagram	154

Chapter 1 Introduction to V6-H Series Inverter

1.1 Product Model Description

The digits and letters in the inverter model field on the nameplate indicate such information as the product series, power supply class, power class and software/hardware versions.

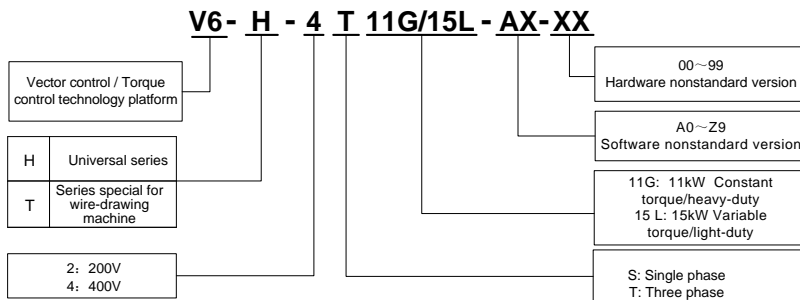

1.2 Product Nameplate Description

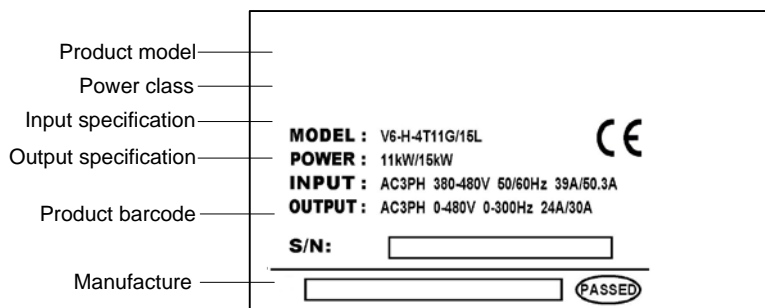

1.3 Product Series

■ V6-H-4T□□□G Three-phase 400V Constant torque/heavy-duty application

Power (kW)	0.75	1.5	2.2	3.7	5.5	7.5	11	15	18.5	22	30	37	45	55	75	
Motor power (kW)	0.75	1.5	2.2	3.7	5.5	7.5	11	15	18.5	22	30	37	45	55	75	
Output	Voltage (V)	Three-phase 0 to rated input voltage														
	Rated current (A)	2.5	3.8	5.5	9	13	17	24	30	39	45	60	75	91	112	150
	Overload capability	50% 1 minute, 180% 10 seconds, 200% 0.5 second, interval: 10 minutes (inverse time lag feature)														
Input	Rated voltage/frequency	Three-phase 380V/480V; 50Hz/60Hz														
	Allowable voltage range	323V ~ 528V; Voltage unbalancedness ≤3%; allowable frequency fluctuation: ±5%														
	Rated current (A)	3.5	6.2	9.2	14.9	21.5	27.9	39	50.3	60	69.3	86	104	124	150	201
Braking unit	Built-in as standard							Built-in as option								
Protection class	IP20															
Cooling mode	Self-cooling		Forced air convection cooling													
Power (kW)	90	110	132	160	185	200	220	250	280	315	355	400	450	500		
Motor power (kW)	90	110	132	160	185	200	220	250	280	315	355	400	450	500		
Output	Voltage (V)	Three-phase 0 to rated input voltage														
	Rated current (A)	176	210	253	304	350	380	426	470	520	600	650	690	775	860	
	Overload capability	50% 1 minute, 180% 10 seconds, 200% 0.5 second, interval: 10 minutes (inverse time lag feature)														
Input	Rated voltage/frequency	Three-phase 380V/480V; 50Hz/60Hz														
	Allowable voltage range	323V ~ 528V; Voltage unbalancedness ≤3%; allowable frequency fluctuation: ±5%														
	Rated current (A)	160*	196*	232*	282*	326*	352*	385*	437*	491*	580*	624*	670*	755*	840*	
Braking unit	External braking unit needed															
Protection class	IP20															
Cooling mode	Forced air convection cooling															

*V6-H-4T90G and above products are equipped with external DC reactor as standard.

■ V6-H-4T□□□L Three-phase 400V Variable torque/light-duty application

Power (kW)	1.5	2.2	3.7	5.5	7.5	11	15	18.5	22	30	37	45	55	75	90	
Motor power (kW)	1.5	2.2	3.7	5.5	7.5	11	15	18.5	22	30	37	45	55	75	90	
Output	Voltage (V)	Three-phase 0 to rated input voltage														
	Rated current (A)	3.3	5.0	7.5	11	17	22	30	37	44	56	72	91	110	142	176
	Overload capability	115% 1 minute, 160% 0.5 second, interval: 10 minutes (inverse time lag feature)														
Input	Rated voltage/frequency	Three-phase 380V/480V; 50Hz/60Hz														
	Allowable voltage fluctuation range	323V ~ 528V; Voltage unbalancedness: ≤3%; allowable frequency fluctuation: ±5%														
	Rated current (A)	5.6	8.1	13.5	19.5	26	39	50.3	60	69.3	86	104	124	150	190	235
Braking unit	Built-in as standard							Built-in as option								
Protection class	IP20															
Cooling mode	Self-cooling			Forced air convection cooling												
Power (kW)	110	132	160	185	200	220	250	280	315	355	400	450	500	560		
Motor power (kW)	110	132	160	185	200	220	250	280	315	355	400	450	500	560		
Output	Voltage (V)	Three-phase 0 to rated input voltage														
	Rated current (A)	210	253	304	350	380	426	470	520	600	650	690	775	860	950	
	Overload capability	115% 1 minute, 160% 0.5 second, interval: 10 minutes (inverse time lag feature)														
Input	Rated voltage/frequency	Three-phase 380V/480V; 50Hz/60Hz														
	Allowable voltage fluctuation range	323V ~ 528V; Voltage unbalancedness ≤3%; allowable frequency fluctuation: ±5%														
	Rated current (A)	196*	232*	282*	326*	352*	385*	437*	491*	580*	624*	670*	755*	840*	920*	
Braking unit	External braking unit needed															
Protection class	IP20															
Cooling mode	Forced air convection cooling															

*V6-H-4T110L and above products are equipped with external DC reactor as standard.

■ V6-H-2T□□□G Three-phase 200V Constant torque/heavy-duty application

Power (kW)	0.4		0.75		1.5		2.2		
Motor power (kW)	0.4		0.75		1.5		2.2		
Output	Voltage (V)	Three-phase 0 to rated input voltage							
	Rated current (A)	3		5		7.5		10	
	Overload capability	150% 1 minute, 180% 10 seconds, 200% 0.5 second, interval: 10 minutes (inverse time lag feature)							
Input	Rated voltage/frequency	Three-phase or single-phase 200V~240V; 50Hz/60Hz							
	Allowable voltage fluctuation range	180V ~ 260V; Voltage unbalancedness ≤3%; allowable frequency fluctuation: ±5%							
	Rated current (A)	3.8		5.5		8.3		12	
Braking unit	Built-in as standard								
Protection class	IP20								
Cooling mode	Self-cooling			Forced air convection cooling					

1.4 Technical Specifications of Product

Control features	Control mode	Vector control 1	Vector control 2 (Without encoder)	Vector control 2 (With encoder)
	Startup torque	0.50Hz 180%	0.25Hz 180%	0.00Hz 180%
	Speed adjustment range	1:100	1:200	1:1000
	Speed stabilization precision	± 0.5%	± 0.2%	± 0.02%
	Torque control	N	Y	Y
	Torque precision	–	±5%	±5%
	Torque response time	–	<20ms	<10ms
Product functions	Key functions	Undervoltage adjustment, switching of AC operation grounding, protective grounding and DC operation grounding, rotation speed tracing, torque limitation, multi-speed operation (up to 23 speeds), auto tuning, S curve acceleration/deceleration, slip compensation, PID adjustment, drooping control, current limiting control, torque control mode and speed control mode switching, manual/auto torque boost. current limiting, multi-functional input/output terminal		
	Frequency setting mode	Operation panel setting, terminal UP/DN setting, host computer communication setting, analog setting AI1/AI2/AI3, terminal pulse DI setting		
	Frequency range	0.00 ~ 300.00Hz Note: Upon the control mode of vector control 1 0.0 ~ 3000.0Hz, which can be customized according to the customer demand		
	Startup frequency	0.00~60.00Hz		
	Acceleration/deceleration time	0.1~36000s		
	Powered braking capability	Braking unit action voltage: 650 ~ 750V; operating time: 100.0s; The braking unit can be embedded for V6-H-4T75G and below equipment		
	DC braking capability	DC braking initial frequency: 0.00 ~ 300.00Hz; DC braking current: Constant torque: 0.0 ~ 120.0%, Variable torque: 0.0 ~ 90.0% DC braking time: 0.0 ~ 30.0s; there is no initial waiting time for the DC braking to realize quick braking		
Magnetic flux braking function	Ongoing action and no action upon deceleration as option, no action upon deceleration at default			
Unique functions	Multifunctional M key	The unique multifunctional key is used to set the frequently used operations: JOG, emergency shutdown, running command reference mode switch , menu switching		
	Multiple menu modes	Basic menu mode, fast menu mode. Menu mode of non-leave-factory value function codes, Menu mode of last changed 10 function codes		
	Parameter copy	The standard operation panel can realize the parameter upload, download and display the copy progress. The user can select to forbid the overwriting of the uploaded parameters.		
	Displayed/hidden function code	The customer can select to display or hide the function codes by themselves.		
	Dual 485 communication ports	Dual 485 communication ports support Modbus protocol (RTU). The standard operation panel can realize remote control box function with a maximum distance of 500m.		
	Operation panel	Button type or shuttle type operation panel optional, protection class: IP20 as standard, IP54 as option		
	Common DC bus	The full series can realize common DC bus supply for several inverters.		

	Independent duct	The full series adopts independent duct design and supports the installation of heatsink outside the cabinet
	Universal expansion interface	Universal expansion board equipped with CPU for supporting customers secondary development: physical interface SPI bus, software protocol Modbus
	Expansion card	User's secondary development card, injection molding machine interface card, PG feedback card, air compressor control card, communication adapter card, power monitoring card, phase sequence detection card, external power rectifying card
	Power-up auto-detection	Realizing the power-up auto-detection of internal and peripheral circuits, including motor grounding, abnormal +10V power supply output, abnormal analog input, and disconnection
Protection function	Power supply undervoltage, overcurrent protection, overvoltage protection, interference protection, abnormal comparison reference input, auto-tuning failure, module protection, heatsink overtemperature protection, inverter overload protection, motor overload protection, peripheral protection, abnormal current detection, output to ground short circuit, abnormal power failure during operation, abnormal input power, output phase failure, abnormal EEPROM, abnormal relay contact, temperature sampling disconnection, encoder disconnection, abnormal +10V power supply output, abnormal analog input, motor overtemperature (PTC), abnormal communication, abnormal version compatibility, abnormal copying, abnormal expansion card connection, terminal mutual exclusion detection failure, hardware overload protection	
Efficiency	At rated power, 7.5kW and below power class $\geq 93\%$, 45kW and below power class $\geq 95\%$, 55kW and above power class $\geq 98\%$	
Environment	Operating site	The product shall be mounted vertically in the electric control cabinet with good ventilation. Horizontal or other installation modes are not allowed. The cooling media is the air. The product shall be installed in the environment free from direct sunlight, dust, corrosive gas, combustible gas, oil mist, steam and drip.
	Ambient temperature	-10 ~ +40°C, derated at 40 ~ 50°C, the rated output current shall be decreased by 1% for every temperature rise of 1°C
	Humidity	5 ~ 95%, no condensing
	Altitude	0 ~ 2000m, derated above 1000m, the rated output current shall be decreased by 1% for every rise of 100m
	Vibration	3.5mm,2~9Hz; 10 m/s ² ,9~200Hz; 15 m/s ² ,200~500Hz
	Storage temperature	-40~+70°C

1.5 Product Component Name

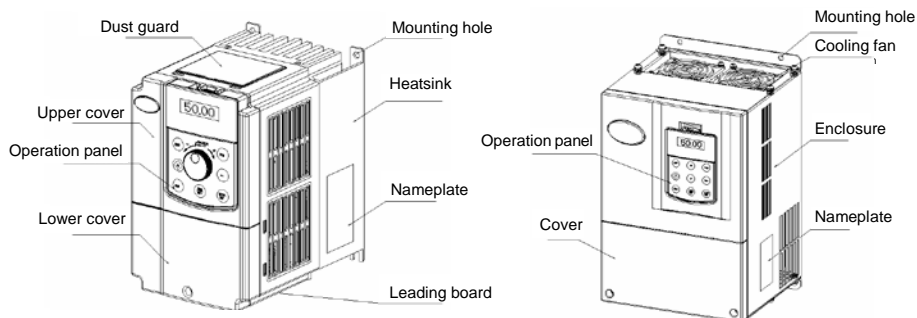

V6-H-2T0.4G~V6-H-2T2.2G

V6-H-4T7.5G/11L and below power class

V6-H-4T11G/15L and above power class

Fig. 1-1 Product component name

1.6 Product Outline, Mounting Dimension, and Weight

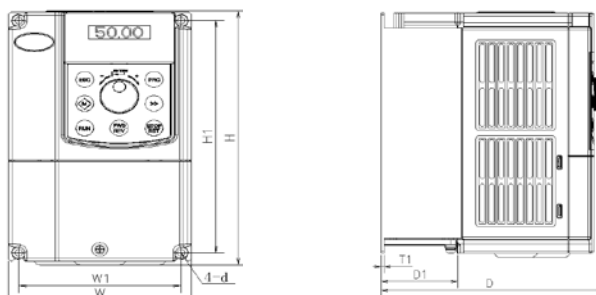

V6-H-2T0.4G~V6-H-2T2.2G, V6-H-4T7.5G/11L and below power class

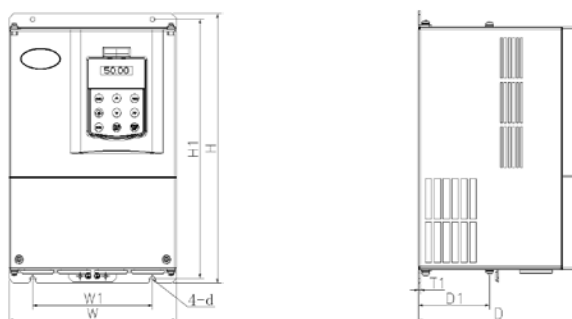

V6-H-4T11G/15L and above power class

Fig. 1-2 Product outline and mounting dimension

Product outline, mounting dimension, and weight

Voltage class	Inverter model	Outline and mounting dimension (mm)								Approximate weight (kg)
		W	H	D	W1	H1	D1	T1	Mounting hole diameter	
200V	V6-H-2T0.4G	118	190	155	105	173	40.8	3	5.5	1.5
	V6-H-2T0.75G			175			60.5	4		2.2
	V6-H-2T1.5G			155			40.8	3		1.5
	V6-H-2T2.2G			175			60.5	4		2.2
400V	V6-H-4T0.75G/1.5L	118	190	155	105	173	40.8	3	5.5	1.5
	V6-H-4T1.5G/2.2L	118	190	175	105	173	60.5	4	5.5	2.6
	V6-H-4T2.2G/3.7L									
	V6-H-4T3.7G/5.5L									
	V6-H-4T5.5G/7.5L	155	249	185	136	232	69	8	5.5	4.5
	V6-H-4T7.5G/11L									
	V6-H-4T11G/15L	210	337	200	150	324	88	2	7	8.5
	V6-H-4T15G/18.5L									
	V6-H-4T18.5G/22L	289	440	220	200	425	88	2.5	7	17
	V6-H-4T22G/30L									
	V6-H-4T30G/37L									
	V6-H-4T37G/45L	319	575	218	220	553	90.5	2.5	10	25
	V6-H-4T45G/55L									
	V6-H-4T55G/75L	404	615	255	270	590	86.5	3.0	10	35
	V6-H-4T75G/90L									
	V6-H-4T90G	465	745	325	343	715	151.5	3.0	12	55
	V6-H-4T110L									
	V6-H-4T110G									
	V6-H-4T132L									
	V6-H-4T132G	540	890	385	370	855	205.5	4.0	14	85
	V6-H-4T160L									
	V6-H-4T160G									
	V6-H-4T185L									
V6-H-4T185G										
V6-H-4T200L										
V6-H-4T200G										
V6-H-4T220L	700	1010	385	520	977	210	4.0	14	125	
V6-H-4T220G										
V6-H-4T250L										
V6-H-4T250G										
V6-H-4T280L										
V6-H-4T280G										
V6-H-4T315L	810	1358	425	520	1300	210	4.0	14	215	
V6-H-4T315G										
V6-H-4T355L										
V6-H-4T355G										
V6-H-4T400L										

Voltage class	Inverter model	Outline and mounting dimension (mm)								Approximate weight (kg)
		W	H	D	W1	H1	D1	T1	Mounting hole diameter	
400V	V6-H-4T400G	810	1358	425	520	1300	210	4.0	14	215
	V6-H-4T450L									
	V6-H-4T450G									
	V6-H-4T500L									
	V6-H-4T500G									
V6-H-4T560L										

1.7 Operation Panel Outline and Mounting Dimension

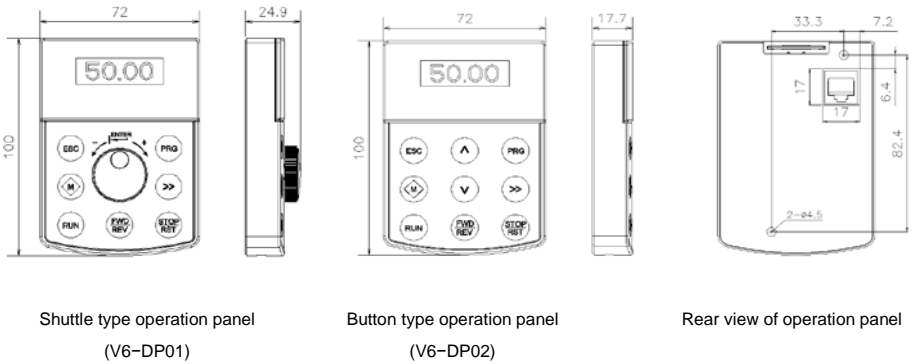

Fig.1-3 Operation panel outline and mounting dimension

Note:

V6-H-4T7.5G/11L and below power class are equipped with shuttle type operation panel (V6-DP01) as standard, V6-H-4T11G/15L and above power class are equipped with button type operation panel (V6-DP02) as standard.

1.8 Pallet Outline and Mounting Dimension

V6-DP05 is the mounting pallet when the operation panel is to install on the electric control cabinet. The outline and dimension are as follows:

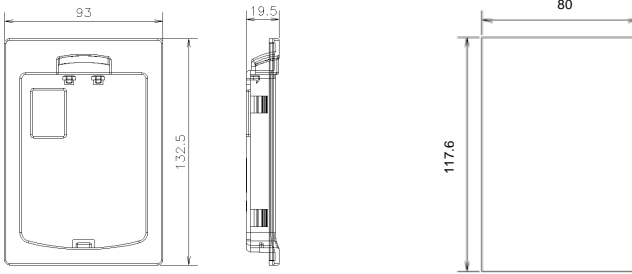

Pallet (V6-DP05)

Open pore dimension of pallet

Fig.1-4 Pallet outline and mounting dimension

1.9 Braking Resistor Lectotype

Inverter model	Braking unit	Braking resistor unit				Braking torque%	
		Power	Resistor	Minimum limit resistor	Qty.		
V6-H-2T0.4G	Built-in as standard	70W	200Ω	200Ω	1	220	
V6-H-2T0.75G		70W	200Ω	200Ω	1	125	
V6-H-2T1.5G		260W	100Ω	100Ω	1	125	
V6-H-2T2.2G		260W	100Ω	100Ω	1	120	
V6-H-4T0.75G/1.5L		110W	750Ω	125Ω	1	130	
V6-H-4T1.5G/2.2L		260W	400Ω	100Ω	1	125	
V6-H-4T2.2G/3.7L		320W	250Ω	100Ω	1	135	
V6-H-4T3.7G/5.5L		550W	150Ω	66.7Ω	1	135	
V6-H-4T5.5G/7.5L		800W	100Ω	66.7Ω	1	135	
V6-H-4T7.5G/11L		1070W	75Ω	66.7Ω	1	130	
V6-H-4T11G/15L		1600W	50Ω	25Ω	1	135	
V6-H-4T15G/18.5L		2000W	40Ω	25Ω	1	125	
V6-H-4T18.5G/22L		Built-in as option	4800W	32Ω	20Ω	1	125
V6-H-4T22G/30L			4800W	27.2Ω	20Ω	1	125
V6-H-4T30G/37L	6000W		20Ω	14Ω	1	125	
V6-H-4T37G/45L	9600W		16Ω	14Ω	1	125	
V6-H-4T45G/55L	9600W		13.6Ω	10Ω	1	125	
V6-H-4T55G/75L	6000W		20Ω	7Ω	2	135	
V6-H-4T75G/90L	9600W		13.6Ω	5Ω	2	145	

Note: The connection mode for multiple braking resistors is parallel connection. For example, the inverter of V6-H-4T55G/75L, the braking resistor lectotype: it is suggest to select two 6000W 20Ω braking resistor parallel connection, amount to braking resistor is 12000W, 10Ω.

Chapter 2 Inverter Installation

2.1 Environment for Product Installation

- Avoid installing the product in the sites with oil mist, metal powder and dust.
- Avoid installing the product in the sites with hazardous gas and liquid, and corrosive, combustible and explosive gas.
- Avoid installing the products in salty sites.
- Do not install the product in the sites with direct sunlight.
- Do not mount the product on the combustible materials, such as wood.
- Keep the drilling scraps from falling into the inside of inverter during the installation.
- Mount the product vertically in the electric control cabinet, mount the cooling fan or air conditioner to prevent the ambient temperature from rising to above 45 °C.
- For the sites with adverse environment, it is recommended to mount the inverter heatsink outside the cabinet.

2.2 Mounting Direction and Space

In order not to reduce the inverter cooling effect, the inverter must be mounted vertically, and certain space must be maintained, as shown in Fig. 2-1 and Fig.2-2.

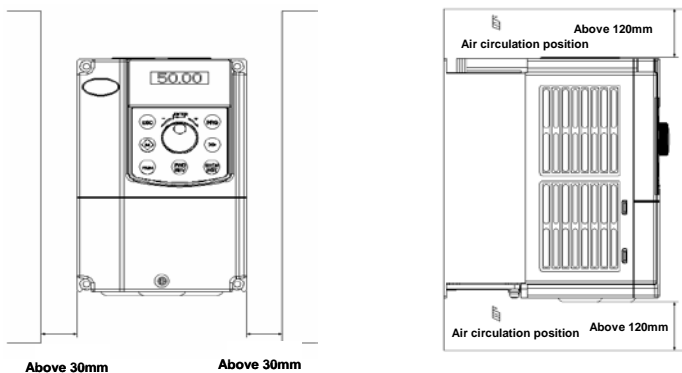

Fig.2-1 Mounting direction and space for V6 -H-2T0.4G~V6-H-2T2.2G and V6-H-4T7.5G/11L and below power class

 Note:

When the V6-H-2T0.4G~V6-H-2T2.2G and V6-H-4T7.5G/11L and below power class inverters are mounted side by side in the cabinet, please remove the upper dust guard and the lower leading board.

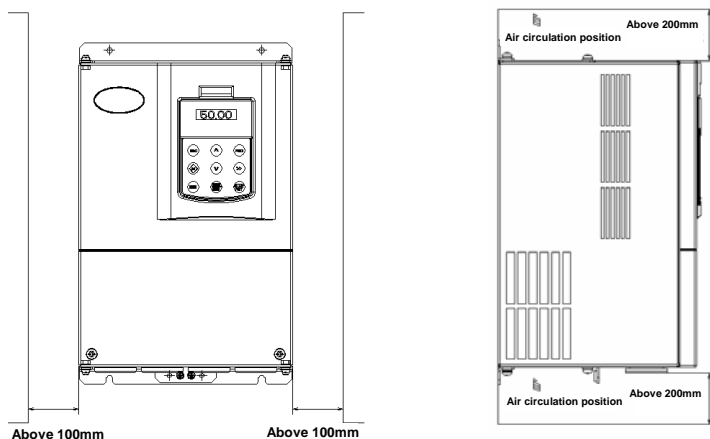

Fig. 2-2 Mounting direction and space for V6-H-4T11G/15L and above power class

2.3 Removal and Mounting of Operation Panel and Cover

2.3.1 Removal and Mounting of Operation Panel

◆ Removal of operation panel

As shown in Fig. 2-3, the grab on the operation panel forcefully in direction 1, and then lift the panel body in direction 2.

◆ Mounting of operation panel

As shown in Fig.2-4, align with the lower clamping position of the operation panel in direction 1, and then press down the operation panel in direction 2, until the “crack” sound is heard.

Do not mount the operation panel in any other direction; otherwise, the operation panel will have poor contact.

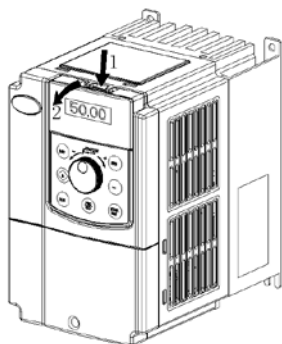

Fig. 2-3 Removal of operation panel

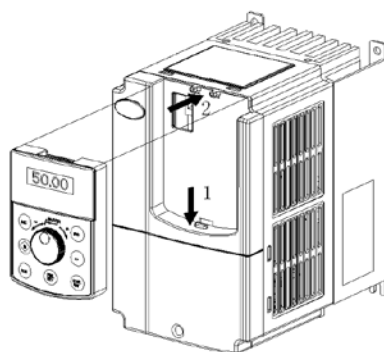

Fig.2-4 Mounting of operation panel

2.3.2 Removal and Mounting of Covers of Inverter with Plastic Enclosure

◆ Removal of operation panel

Please refer to 2.3.1 removal and mounting of operation panel.

◆ Removal of lower cover

After removing the mounting screws of the cover, press the left and right sides of the cover forcefully in direction 1 and at the same time lift the cover in direction 2, as shown in Fig. 2-5.

◆ Removal of upper cover

As shown in Fig.2-6, press the left and right sides of the cover forcefully in direction 1, and at the same time lift the cover in direction 2.

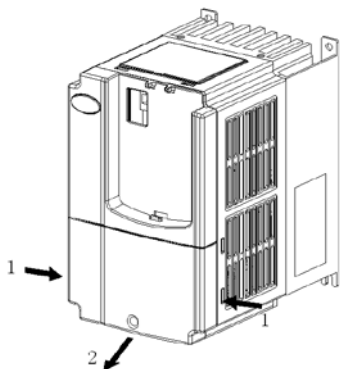

Fig.2-5 Removal of lower cover

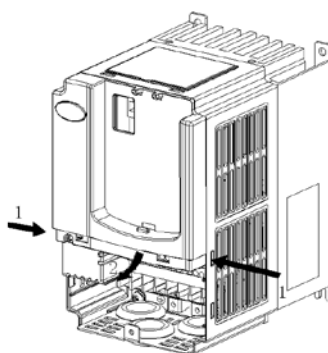

Fig.2-6 Removal of upper cover

◆ Mounting of upper cover

After the wiring of main circuit terminals and control circuit terminals, insert the upper claw grab of the upper cover into the groove of the inverter body, as shown in position 1 in Fig.2-7, and then

press the lower part of the upper cover in direction 2 as shown in Fig.2-7, until the “crack” sound is heard.

◆ Mounting of lower cover

Insert the upper claw grab on the lower cover into the groove of the upper cover, as shown in position 1 of Fig.2-8, and then press the lower part of the lower cover in direction 2 of Fig.2-8, until the “crack” sound is heard. Now, tighten the cover screws.

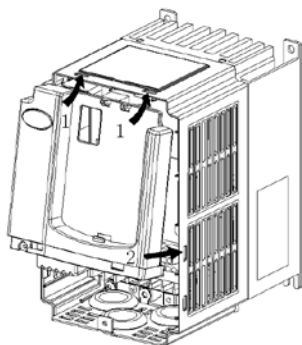

Fig.2-7 Mounting of upper cover

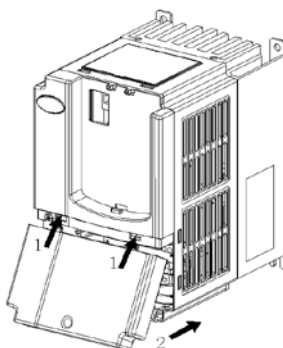

Fig.2-8 Mounting of lower cover

◆ Mounting of operation panel

Please refer to 2.3.1 Removal and mounting of operation panel.

2.3.3 Removal and Mounting of Covers of V6-H-4T11G/15L~V6-H-4T75G/90L and Above Power Class Inverter with Sheet-metal Enclosure

◆ Removal of operation panel

Please refer to 2.3.1 Removal and mounting of operation panel.

◆ Removal of cover

Remove the mounting screws on the lower part of the cover, lift the cover in direction 1 as shown in Fig.2-9, and then take out the cover in direction 2.

◆ Mounting of cover

After the wiring of the main circuit terminals and control circuit terminals, cramp the cover in direction 1 as shown in Fig.2-10, press down the cover in direction 2 and then tighten the cover screws.

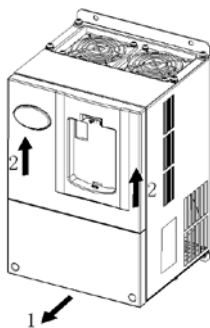

Fig.2-9 Removal of cover

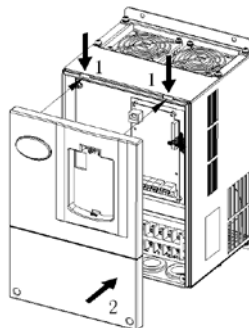

Fig.2-10 Mounting of cover

◆ Mounting of operation panel

Please refer to 2.3.1 Removal and mounting of operation panel.



Note:

Do not directly mount the cover with operation panel on the inverter, otherwise, the operation panel will have poor contact.

2.3.4 Open and Close of Doors of V6-H-4T90G/110L and Above Power Class Inverter with Sheet-metal Enclosure

◆ Opening of the door

Press the latch following direction 1 in Fig.2-11 and open the door following direction 2.

◆ Removal of operation panel

The operation panel is connected to the control board through the standard network cable and will not interfere with the open/close of the door. To remove the operation panel, refer to section 2.3.1 Removal and Mounting of Operation Panel

◆ Mounting of cover

After the wiring operation of main circuit terminals and control circuit terminals is completed, close the door following direction 1 in Fig.2-12, and then press down the latch following direction 2 to lock the door.

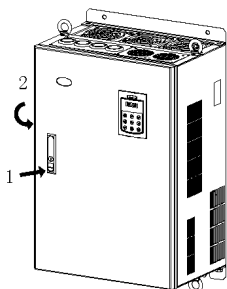

Fig. 2-11 opening the door

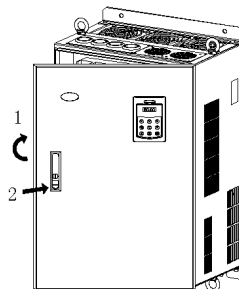

Fig. 2-12 closing the door

Chapter 3 Wiring of Inverter

3.1 Connection of the Product and Peripheral Devices

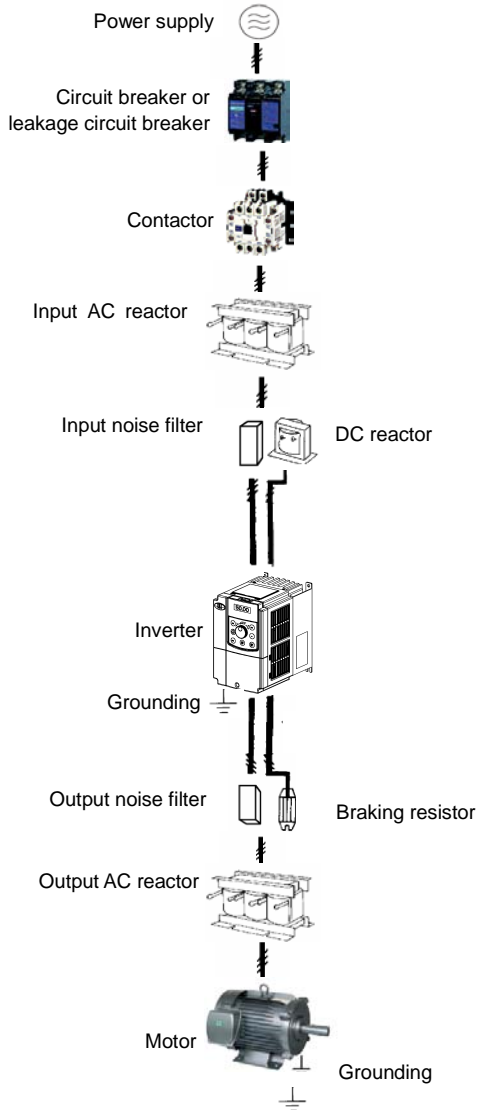

Fig.3-1 Connection diagram of the product and peripheral devices

3.2 Description of Peripheral Devices for Main Circuit

Circuit breaker	The capacity of the circuit breaker shall be 1.5 ~ 2 time of the rated current of the inverter. The time features of the circuit breaker shall fully consider the time features of the inverter overload protection.
Leakage circuit breaker	Because the inverter output is the high-frequency pulse, there will be high-frequency leakage current. Special leakage circuit breaker shall be used when installing leakage circuit breaker at the input end of the inverter. It is suggested that B type leakage circuit breaker be used, and the leakage current value shall be set as 300mA.
Contactors	Frequent open and close of contactor will cause inverter failure, so the highest frequency for the open and close of contactor shall not exceed 10 times/min. When braking resistor is used, to void the overtemperature damage of the braking resistor, thermal protection relay with braking resistor overtemperature detection shall be installed to disconnect the contactor at the contact control power side of the thermal protection relay.
Input AC reactor or DC reactor	<ol style="list-style-type: none"> The inverter power supply capacity is more than 600kVA or 10 times of the inverter capacity. If there is switch type reactive-load compensation capacitor or load with silicon control at the same power node, there will be high peak current flowing into input power circuit, causing the damage of the rectifier components. When the voltage unbalancedness of the three-phase power supply of the inverter exceeds 3%, the rectifier component will be damaged. It is required that the input power factor of the inverter shall be higher than 90%. When the above situations occur, install the AC reactor at the input end of the inverter or DC reactor to the DC reactor terminal.
Input noise filter	The noise input from the power end to the inverter and output from the inverter to the power end can be reduced.
Thermal protection relay	Although the inverter has motor overload protection function, when one inverter drives two or more motors or multi-pole motors, to prevent the motor overtemperature failure, thermal protection relay shall be installed between the inverter and each motor, and the motor overload protection parameter P9.16 shall be set as "2" (motor protection disabled).
Output noise filter	When the output end of the inverter is connected with noise filter, the conduction and radiation interference can be reduced.
Output AC reactor	When the cable connecting the inverter and the motor is longer than 100m, it is suggested to install AC output reactor to suppress the high-frequency oscillation to avoid the damage to motor insulation, large leakage current and frequent inverter protective action.

3.3 Lectotype of mMain Circuit Peripheral Devices

Inverter model	Circuit Breaker (A)	Contactor (A)	R/L1, S/L2, T/L3, ⊕1, ⊕2/B1, B2, ⊖, U/T1, V/T2, W/T3			Grounding terminal PE ⊕		
			Terminal screw	Tightening torque (N·m)	Wire specification (mm ²)	Terminal screw	Tightening torque (N·m)	Wire specification (mm ²)
V6-H-2T0.4G	16	10	M4	1.2~1.5	2.5	M4	1.2~1.5	2.5
V6-H-2T0.75G	25	16	M4	1.2~1.5	2.5	M4	1.2~1.5	2.5
V6-H-2T1.5G	32	25	M4	1.2~1.5	4	M4	1.2~1.5	2.5
V6-H-2T2.2G	40	32	M4	1.2~1.5	6	M4	1.2~1.5	4
V6-H-4T0.75G/1.5L	10	10	M4	1.2~1.5	2.5	M4	1.2~1.5	2.5
V6-H-4T1.5G/2.2L	16	10	M4	1.2~1.5	2.5	M4	1.2~1.5	2.5
V6-H-4T2.2G/3.7L	16	10	M4	1.2~1.5	2.5	M4	1.2~1.5	2.5
V6-H-4T3.7G/5.5L	25	16	M4	1.2~1.5	4	M4	1.2~1.5	4
V6-H-4T5.5G/7.5L	32	25	M4	1.2~1.5	6	M4	1.2~1.5	6
V6-H-4T7.5G/11L	40	32	M4	1.2~1.5	6	M4	1.2~1.5	6

Inverter model	Circuit Breaker (A)	Contactor (A)	R/L1, S/L2, T/L3, ⊕1, ⊕2/B1, B2, ⊖, U/T1, V/T2, W/T3			Grounding terminal PE ⊕		
			Terminal screw	Tightening torque (N·m)	Wire specification (mm ²)	Terminal screw	Tightening torque (N·m)	Wire specification (mm ²)
V6-H-4T11G/15L	63	40	M5	2.5~3.0	6	M5	2.5~3.0	6
V6-H-4T15G/18.5L	63	63	M5	2.5~3.0	6	M5	2.5~3.0	6
V6-H-4T18.5G/22L	100	63	M6	4.0~5.0	10	M6	4.0~5.0	10
V6-H-4T22G/30L	100	100	M6	4.0~5.0	16	M6	4.0~5.0	16
V6-H-4T30G/37L	125	100	M6	4.0~5.0	25	M6	4.0~5.0	16
V6-H-4T37G/45L	160	100	M8	9.0~10.0	25	M8	9.0~10.0	16
V6-H-4T45G/55L	200	125	M8	9.0~10.0	35	M8	9.0~10.0	16
V6-H-4T55G/75L	315	250	M10	17.6~22.5	50	M10	14.0~15.0	25
V6-H-4T75G/90L	350	330	M10	17.6~22.5	60	M10	14.0~15.0	35
V6-H-4T90G	315	250	M10	17.6~22.5	70	M10	14.0~15.0	35
V6-H-4T110L	350	330	M10	17.6~22.5	100	M10	14.0~15.0	50
V6-H-4T110G	350	330	M10	17.6~22.5	100	M10	14.0~15.0	50
V6-H-4T132L	400	330	M12	31.4~39.2	150	M12	17.6~22.5	75
V6-H-4T132G	400	330	M12	31.4~39.2	150	M12	17.6~22.5	75
V6-H-4T160L	500	400	M12	31.4~39.2	185	M12	17.6~22.5	50x2
V6-H-4T160G	500	400	M12	31.4~39.2	185	M12	17.6~22.5	50x2
V6-H-4T185L	630	500	M12	48.6~59.4	240	M12	31.4~39.2	60x2
V6-H-4T185G	630	500	M12	48.6~59.4	240	M12	31.4~39.2	60x2
V6-H-4T200L	630	500	M12	48.6~59.4	240	M12	31.4~39.2	60x2
V6-H-4T200G	630	500	M12	48.6~59.4	240	M12	31.4~39.2	60x2
V6-H-4T220L	800	630	M12	48.6~59.4	150x2	M12	31.4~39.2	75x2
V6-H-4T220G	800	630	M12	48.6~59.4	150x2	M12	31.4~39.2	75x2
V6-H-4T250L	1000	630	M12	48.6~59.4	185x2	M12	31.4~39.2	100x2
V6-H-4T250G	1000	630	M12	48.6~59.4	185x2	M12	31.4~39.2	100x2
V6-H-4T280L	1000	630	M12	48.6~59.4	185x2	M12	31.4~39.2	100x2
V6-H-4T280G	1000	630	M12	48.6~59.4	185x2	M12	31.4~39.2	100x2
V6-H-4T315L	1000	800	M14	48.6~59.4	250x2	M14	31.4~39.2	125x2
V6-H-4T315G	1000	800	M14	48.6~59.4	250x2	M14	31.4~39.2	125x2
V6-H-4T355L	1200	800	M14	48.6~59.4	325x2	M14	31.4~39.2	150x2
V6-H-4T355G	1200	800	M14	48.6~59.4	325x2	M14	31.4~39.2	150x2
V6-H-4T400L	1500	1000	M14	48.6~59.4	325x2	M14	31.4~39.2	150x2
V6-H-4T400G	1500	1000	M14	48.6~59.4	325x2	M14	31.4~39.2	150x2
V6-H-4T450L	2000	1500	M14	48.6~59.4	350x2	M14	31.4~39.2	175x2
V6-H-4T450G	2000	1500	M14	48.6~59.4	350x2	M14	31.4~39.2	175x2
V6-H-4T500L	2000	1500	M14	48.6~59.4	350x2	M14	31.4~39.2	175x2
V6-H-4T500G	2000	1500	M14	48.6~59.4	350x2	M14	31.4~39.2	175x2
V6-H-4T560L	2000	1500	M14	48.6~59.4	350x2	M14	31.4~39.2	175x2
V6-H-4T560G	2000	1500	M14	48.6~59.4	350x2	M14	31.4~39.2	175x2

3.4 Product Terminal Configuration

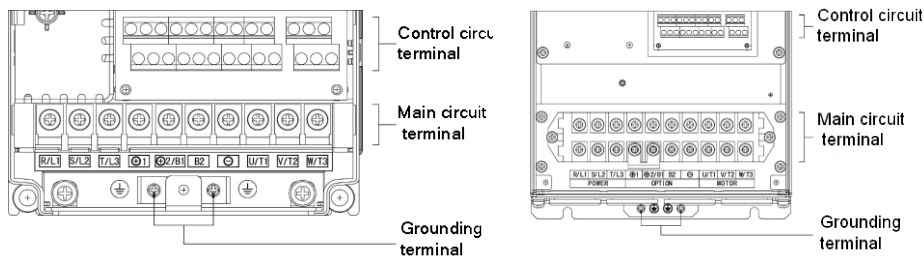

V6-H-2T0.4G~V6-H-2T2.2G

V6-H-4T7.5G/11L and below power class

V6-H-4T11G/15L and above power class

Fig.3-2 Product terminal configuration

3.5 Functions of Main Circuit Terminal

3.5.1 V6-H-2T0.4G~V6-H-2T2.2G and V6-H-4T0.75G/1.5L~V6-H-4T15G/18.5L

R/L1	S/L2	T/L3	⊕1	⊕2/B1	B2	⊖	U/T1	V/T2	W/T3
POWER			OPTION			MOTOR			

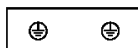

Terminal symbol	Terminal name and function description
R/L1, S/L2, T/L3	Three-phase AC input terminal
⊕1, ⊕2/B1	DC reactor connecting terminal, short circuited with copper bus upon delivery
⊕2/B1, B2	Connecting terminal of braking resistor
⊕2/B1, ⊖	DC power input terminal; DC input terminal of external braking unit
U/T1, V/T2, W/T3	Three-phase AC output terminal
⊕	Grounding terminal PE

3.5.2 V6H-4T18.5G/22L~V6-H-4T75G/90L

R/L1	S/L2	T/L3	⊕1	⊕2	⊖	U/T1	V/T2	W/T3
POWER			OPTION		MOTOR			

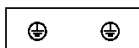

Terminal symbol	Terminal name and function description
R/L1, S/L2, T/L3	Three-phase AC input terminal
⊕1, ⊕2	DC reactor connecting terminal, short circuited with copper bus upon delivery
⊕2, ⊖	DC power input terminal; DC input terminal of external braking unit
U/T1, V/T2, W/T3	Three-phase AC output terminal
⊕	Grounding terminal PE

3.5.3 Internal Braking Unit Option for V6-H-4T18.5G/22L~V6-H-4T75G/90L

R/L1	S/L2	T/L3	B1	B2	⊖	U/T1	V/T2	W/T3
POWER			OPTION			MOTOR		

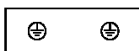

Terminal symbol	Terminal name and function description
R/L1, S/L2, T/L3	Three-phase AC input terminal
B1, ⊖ *	DC reactor connecting terminal *
B1, B2 *	Connecting terminal of braking resistor *
U/T1, V/T2, W/T3	Three-phase AC output terminal
⊕	Grounding terminal PE

Note: *The product equipped with braking unit as standard can realized common DC bus and braking function, if needed connect DC reactor and braking function should contact factory, and the terminal of main circuit B1、B2、⊖ should change to ⊕1、⊕2/B1、B2.

3.5.4 V6-H-4T90G~V6-H-4T500G and V6-H-4T110L~V6-H-4T560L

The inverters of V6-H-4T90G~V6-H-4T500G and V6-H-4T110L~V6-H-4T560L adopt the top in bottom out wiring mode



Terminal symbol	Terminal name and function description
R/L1, S/L2, T/L3	Three-phase AC input terminal
⊕1, ⊕2	DC reactor connecting terminal, if don't connect DC reactor, the inverter will not display after power on.
⊕2, ⊖	DC power input terminal; DC output terminal of external braking unit
U/T1, V/T2, W/T3	Three-phase AC output terminal
⊕	Grounding terminal PE

3.6 Attention for Main Circuit Wiring

3.6.1 Power Supply Wiring

- ◆ It is forbidden to connect the power cable to the inverter output terminal, otherwise, the internal components of the inverter will be damaged.
- ◆ To facilitate the input side overcurrent protection and power failure maintenance, the inverter shall connect to the power supply through the circuit breaker or leakage circuit breaker and contactor.
- ◆ Please confirm that the power supply phases, rated voltage are consistent with that of the nameplate,

otherwise, the inverter may be damaged.

3.6.2 Motor Wiring

- ◆ It is forbidden to short circuit or ground the inverter output terminal, otherwise the internal components of the inverter will be damaged.
- ◆ Avoid short circuit the output cable and the inverter enclosure, otherwise there exists the danger of electric shock.
- ◆ It is forbidden to connect the output terminal of the inverter to the capacitor or LC/RC noise filter with phase lead, otherwise, the internal components of the inverter may be damaged.
- ◆ When contactor is installed between the inverter and the motor, it is forbidden to switch on/off the contactor during the running of the inverter, otherwise, there will be large current flowing into the inverter, triggering the inverter protection action.
- ◆ Length of cable between the inverter and motor

If the cable between the inverter and the motor is too long, the higher harmonic leakage current of the output end will cause adverse impact on the inverter and the peripheral devices. It is suggested that when the motor cable is longer than 100m, output AC reactor be installed. Refer to the following table for the carrier frequency setting.

Length of cable between the inverter and motor	Less than 50m	Less than 100 m	More than 100m
Carrier frequency (PA.00)	Less than 15kHz	Less than 10kHz	Less than 5kHz

3.6.3 Grounding Wiring

- ◆ The inverter will produce leakage current. The higher the carrier frequency is, the larger the leakage current will be. The leakage current of the inverter system is more than 3.5mA, and the specific value of the leakage current is determined by the use conditions. To ensure the safety, the inverter and the motor must be grounded.
- ◆ The grounding resistance shall be less than 10ohm. For the grounding wire diameter requirement, refer to 3.3 lectotype of main circuit peripheral devices.
- ◆ Do not share grounding wire with the welding machine and other power equipment.
- ◆ In the applications with more than 2 inverters, keep the grounding wire from forming a loop.

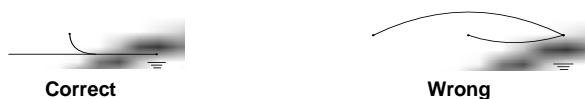

Fig. 3-3 Grounding wiring

3.6.4 Countermeasures for Conduction and Radiation Interference

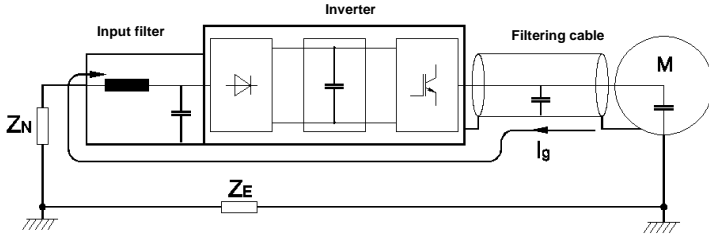

Fig.3-4 Noise current illustration

- ◆ When the input noise filter is installed, the wire connecting the filter to the inverter input power end shall be as short as possible.
- ◆ The filter enclosure and mounting cabinet shall be reliably connected in large area to reduce the back flow impedance of the noise current I_g .
- ◆ The wire connecting the inverter and the motor shall be as short as possible. The motor cable adopts 4-core cable, with the grounding end grounded at the inverter side, the other end connected to the motor enclosure. The motor cable shall be sleeved into the metal tube.
- ◆ The input power wire and output motor wire shall be kept away from each other as long as possible.
- ◆ The equipment and signal cables vulnerable to influence shall be kept far away from the inverter.
- ◆ Key signal cables shall adopt shielding cable. It is suggested that the shielding layer shall be grounded with 360-degree grounding method and sleeved into the metal tube. The signal cable shall be kept far away from the inverter input wire and output motor wire. If the signal cable must cross the input wire and output motor wire, they shall be kept orthogonal.
- ◆ When analog voltage and current signals are adopted for remote frequency setting, twinning shielding cable shall be used. The shielding layer shall be connected to the grounding terminal PE of the inverter, and the signal cable shall be no longer than 50m.
- ◆ The wires of the control circuit terminals RA/RB/RC and other control circuit terminals shall be separately routed.
- ◆ It is forbidden to short circuit the shielding layer and other signal cables or equipment.
- ◆ When the inverter is connected to the inductive load equipment (e.g. electromagnetic contactor, relay and solenoid valve), surge suppressor must be installed on the load equipment coil, as shown in Fig.3-5.

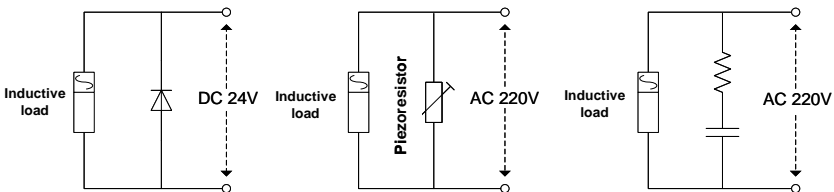

Fig.3-5 Application of inductive load surge suppressor

3.7 Terminal Wiring

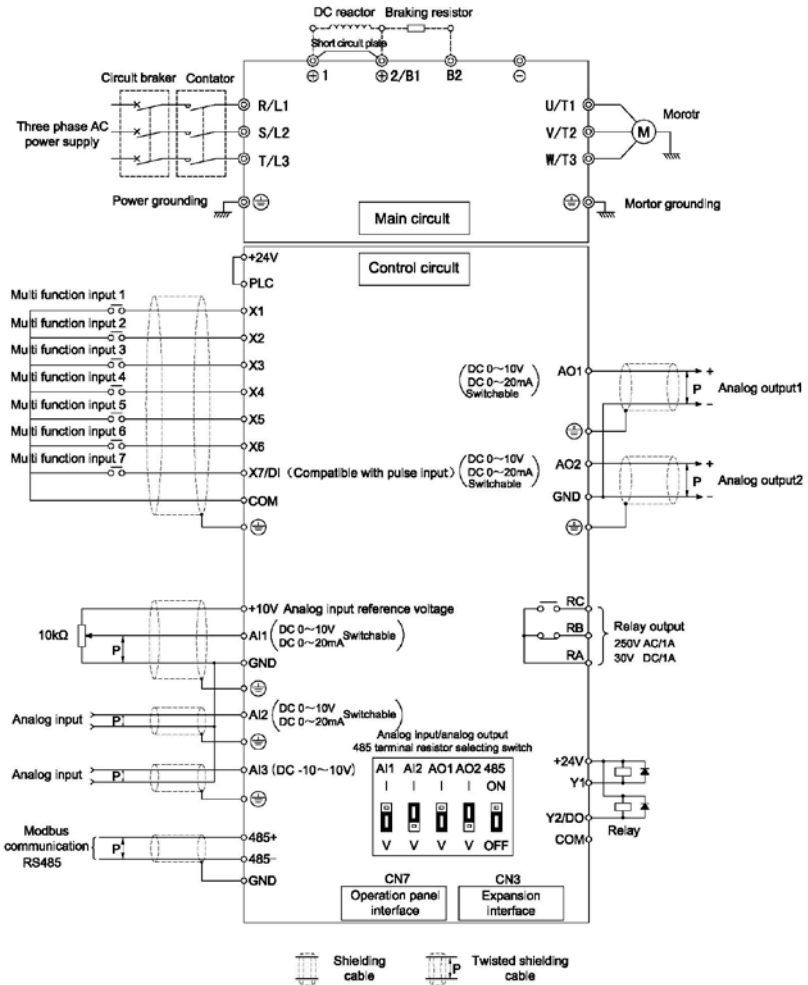

Fig.3-6 Terminal wiring diagram (take V6 -H-4T5.5G/7.5Las an example)

3.8 Functions of Control Circuit Terminals

Type	Terminal symbol	Terminal function description	Technical specification
Terminal 485	485+	Positive end of 485 differential signal	Rate: 4800/9600/19200/38400/57600bps Up to 32 sets of equipment can be paralleled. Relay shall be used if the number exceeds 32. Maximum distance: 500m (adopt standard twisted shielding cable)
	485-	Negative end of 485 differential signal	
	GND	Shielding grounding of 485 communication	Internal isolated with COM
Operation panel 485	CN7	485 port of operation panel	When used for communication connection with host computer, it is the same as terminal 485. The maximum distance is 15m for the communication connection of operation panel (adopt standard twisted non-shielding network cable)
Digital input	+24V	+24V	24V±10%, internal isolated with GND, Maximum load: 200mA, with overload and short circuit protection
	PLC	Common end of multi-functional input terminal	Short circuited with +24V upon delivery
	X1~X6	Multi-functional input terminals 1 ~ 6	Input specification: 24VDC,5mA Frequency range: 0~200Hz Voltage range: 24V±20%
	X7/DI	Multi-functional input or pulse input	Multi-functional input: same as X1~X6 Pulse input: 0.1Hz~50kHz; voltage range: 24V±20%
	COM	+24V grounding	Internal isolated with GND
Digital output	Y1	Open collector output	Voltage range: 24V±20%, maximum input current: 50mA
	Y2/DO	Open collector or pulse output	Open collector: Same as Y1 Pulse output: 0~50kHz; voltage range: 24V±20%
	COM	Open collector output common end	Internal isolated with GND
Analog input	+10V	Analog input reference voltage	10V ±3%, internal isolated with COM, Maximum output current: 10mA, with short circuit and overload protection
	AI1	Analog input channel 1	0~20mA: Input impedance 500 maximum input current: 30mA 0~10V: Input impedance 20k maximum input voltage: 15V Resolution: 12 bits (0.025%) 0~20mA or 0~10V analog input can be selected through jumper.
	AI2	Analog input channel 2	Same as AI1
	AI3	Analog input channel 3	-10V~10V: Input impedance 20kΩ Resolution: 12 bits (0.025%) Maximum input voltage: ±15V
	GND	Analog grounding	Internal isolated with COM
Analog output	AO1	Analog output 1	0~20mA: allowable output impedance 200~500Ω 0~10V: allowable output impedance ≥10kΩ Output precision: 2%, resolution: 10 bits (0.1%) with short circuit protection function, 0~20mA or 0~10V analog output can be selected through jumper.
	AO2	Analog output 2	Same as AO1
	GND	Analog grounding	Internal isolated with COM

Type	Terminal symbol	Terminal function description	Technical specification
Relay output	RA/RB/RC	Relay output	RA-RB: Normally closed RA-RC: Normally open Contact capacity: 250VAC/1A, 30VDC/1A

Note: * If the user connects adjustable potentiometer between +10V and GND, the resistance of the potentiometer shall be no less than 5kΩ,

Note:

1. The arrangement sequence of the control circuit terminals is as follows:

+10V	AI1	AI2	AI3	GND	AO1	AO2	GND	485+	485-	RA	RB	RC
+24V	PLC	COM	X1	X2	X3	X4	X5	X8	X7/DI	Y1	Y2/DO	COM

2. Wiring mode of the multi-functional input/output terminals

- When the internal +24V power supply of the inverter is used, the external controller adopts NPN sink current wiring mode.

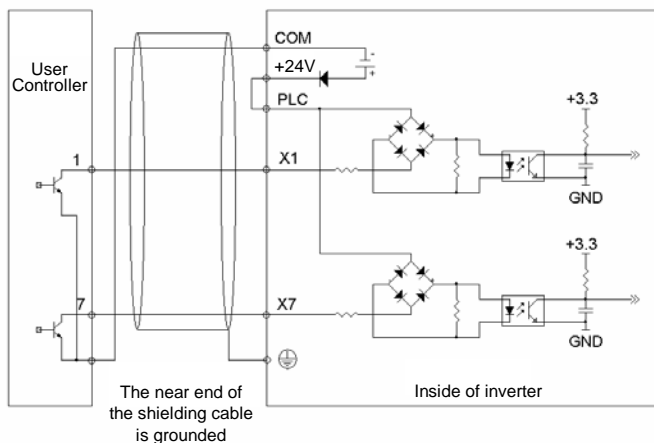

- When the internal +24V power supply of the inverter is used, the external controller adopts PNP draw-off current wiring mode.

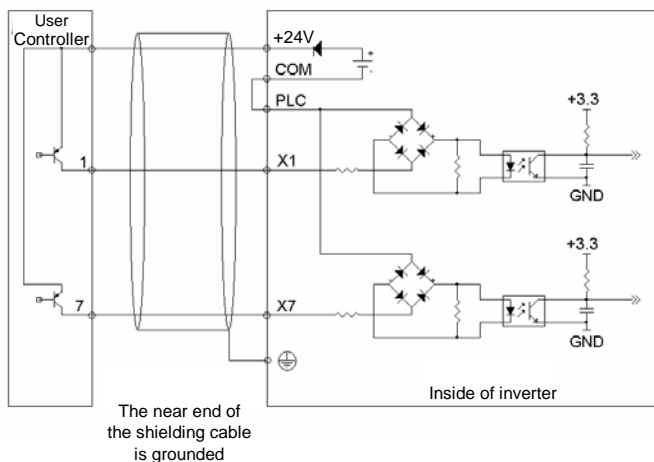

Note: The short circuit plate between terminal +24V and terminal PLC must be removed and short circuit plate shall be connected between PLC and COM terminals.

- When the external power supply is used, the external controller adopts NPN sink current wiring mode.

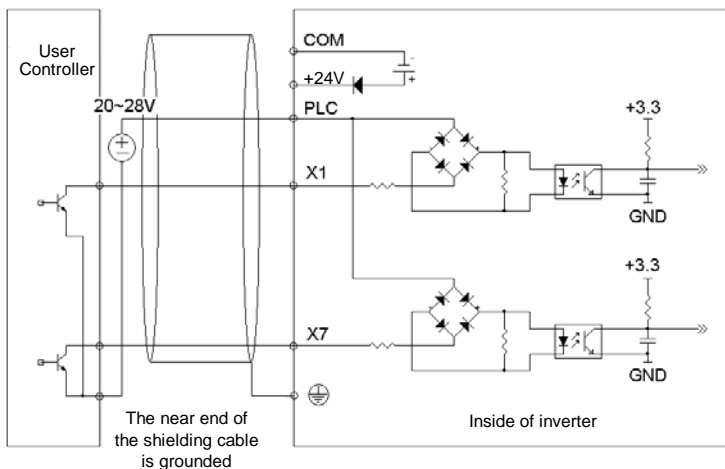

Note: The short circuit plate between terminal +24V and terminal PLC must be removed.

- When the external power supply is used, the external controller adopts PNP draw-off current wiring mode.

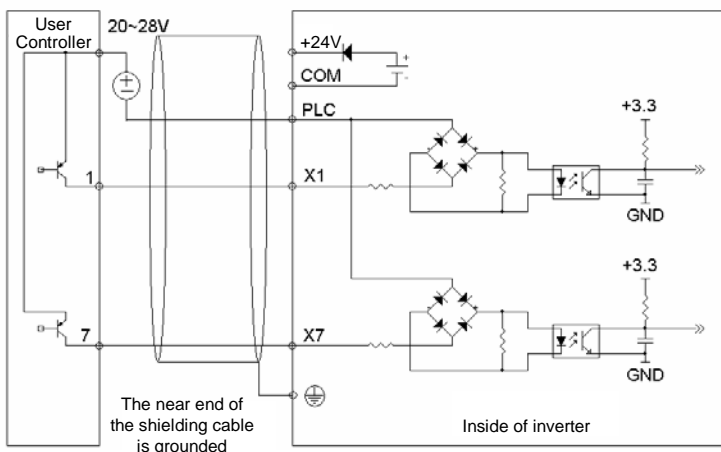

Note: The short circuit plate between terminal +24V and terminal PLC must be removed.

- The wiring modes of the multi-functional output terminals when the internal +24V power supply of the inverter and external power supply are used

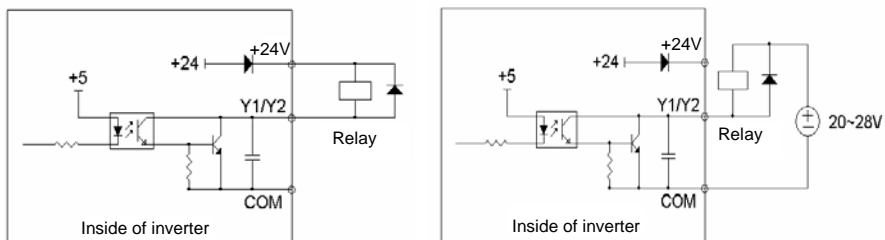

Note: When this wiring mode is adopted, if Y1 or Y2 terminal is damaged, the polarity of the external diode must be checked to ensure the correctness.

3.9 Schematic Diagram of Control Board

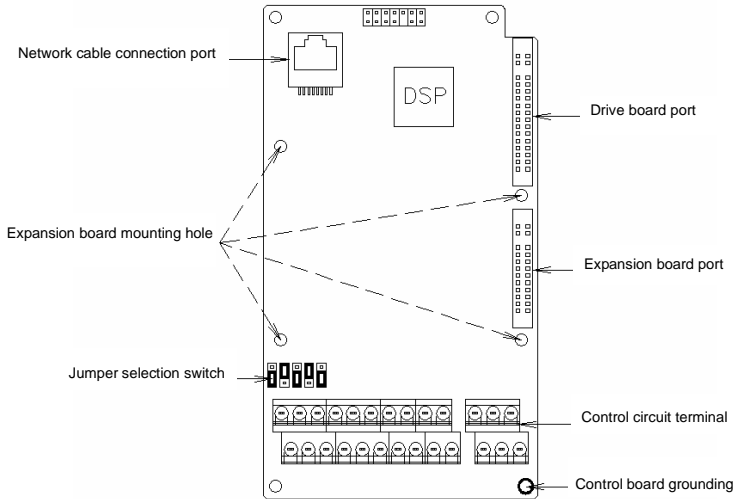

Fig.3-7 Schematic diagram of control board

3.10 Lectotype of Control Circuit Peripheral Devices

Terminal number	Terminal screw	Tightening torque (N·m)	Wire specification mm ²	Wire type
+10V, AI1, AI2, AI3, 485+, 485- AO1, AO2, GND	M3	0.5~0.6	0.75	Twinning shielding cable
+24V, PLC, X1, X2, X3, X4, X5, X6, X7/DI, COM, Y1, Y2/DO, COM, RA, RB, RC	M3	0.5~0.6	0.75	Shielding cable

3.11 Description of Jumper Function

Jumper selecting switch in Fig.3-7:



Name	Function	Leave-factory setting
AI1	I is the current input (0~20mA), V is the voltage input (0~10V)	0~10V
AI2	I is the current input (0~20mA), V is the voltage input (0~10V)	0~20mA
AO1	I is the current output (0~20mA), V is the voltage output (0~10V)	0~10V
AO2	I is the current output (0~20mA), V is the voltage output (0~10V)	0~20mA
485	485 terminal resistor selection: ON: there is 10Ω terminal resistor, OFF: there is no terminal resistor	There is no terminal resistor

Chapter 4 Using Instructions of Operation Panel

4.1 Introduction to Operation Panel



Shuttle type operation panel (V6-DP01)

















Key-type operation panel (V6-DP02)

Fig. 4-1 Display unit of operation panel

4.2 Descriptions of Indicators

Symbol of Indicator		Name	Meanings	Color
Unit indicator	Hz	Frequency indicator	On: Current display parameter is running frequency Flash: Current display parameter is setting frequency	Green
	A	Current indicator	On: Current display parameter is current	Green
	V	Voltage indicator	On: Current display parameter is voltage	Green
	Hz+A	Rotating speed indicator	On: Current display parameter is rotating speed Flash: Current display parameter is setting rotating speed	Green
	Hz+V	% indicator	On: Current display parameter is %	Green
	A+V	Self definable indicator	On/Flash: Current display parameter is self-defined, see description of P2 group.	Green
	Hz+A+V	Time indicator	On: Current display parameter is time	Green
No unit indicator		Off: Current display parameter is no unit	-	
Status indicator	MULTI	Multi-function key indicator	Refer to table 4-1 for using method of multi function keys and the meanings of MULTI indicator	Red
	MON	Running command reference mode indicator	On: Running command is given via operation panel Off: Running command is given via terminals Flash: Running command is given via host computer	Red
	RUN	Running status indicator	On: Inverter is running Off: Inverter has stopped Flash: Inverter is stopping	Red
	FWD	Run forward indicator	On: In stop status, inverter has run forward command; In running status, inverter is running forward Flash: Changing from running forward to running reverse	Red
	REV	Run reverse indicator	On: In stop status, inverter has run reverse command; In running status, inverter is running reverse Flash: Changing from running reverse to running forward	Red

4.3 Description of Keys on Operation Panel

Symbol		Name	Function
Key-type	Shuttle-type		
		Programming key PRG	<ol style="list-style-type: none"> 1、 Enter each level of menu 2、 Confirm data storage 3、 Check function code in sequence 4、 Confirm the running command reference mode with M key
		Escape Key ESC	<ol style="list-style-type: none"> 1、 Back to first level menu from second level menu; Back from first level menu to standby status, running status, and fault status 2、 Give up data storage after modifying data. 3、 Back to basic menu mode after pressing this key for more than 5s. Refer to 4.4.3. When LCD cannot display all the function codes, use this method to re-display all the function codes. 4、 After using >> key to switch from fault display to Stop / Run parameter display, press ESC to back to fault display status.
		Increase Key ▲	<ol style="list-style-type: none"> 1、 In first level menu, increase function code according to edit bit. 2、 In second level menu, increase the function code data. 3、 In stop/run status, increase the input frequency or close loop input.
		Decrease Key ▼	<ol style="list-style-type: none"> 1、 In first level menu, decrease function code according to edit bit. 2、 In second level menu, decrease the function code data. 3、 In stop/run status, decrease the input frequency or close loop input.
		Shift Key >>	<ol style="list-style-type: none"> 1、 In first level menu, use >> key to move edit bit of PX.YZ menu 2、 In second level menu, use >> key to move the edit bit of data 3、 In stop/run status, switch the panel display parameters such as frequency, current and voltage. 4、 In fault status, change from fault display to stop/run display.
		Run Key RUN	<ol style="list-style-type: none"> 1、 When running command is given via operation panel, the key is used to control the start of inverter. 2、 After setting the parameter auto tuning, start parameter auto tuning for inverter startup
		Stop/Reset Key STOP/RST	<ol style="list-style-type: none"> 1、 When running command is given via operation panel, the key is used to control the stop of inverter. 2、 This key is used as a stop key when inverter only has fault alarm but does not stop. 3、 When the inverter has fault and has stopped, this key is used as RESET key to clear the fault alarm.
		Multi-function Key M	See table 4-1 for the using method of multi-function key and the meanings of MULTI indicator.
		Forward/reverse Key FWD/REV	When running command is given via operation panel, this key is used to confirm the output direction of inverter

Note:

- ◆ The ENTER key of shuttle type operation panel is equivalent to **PRG** Key.
- ◆ Using **PRG** key continuously can realize fast browse of all function codes.

Table 4-1 Method of using multi-function key and meanings of MULTI indicator

Definition of M key (P2.01)	Function	Meanings of function	Meanings of MULTI indicator
0	No function	Multi-function key is defined as no function.	Normally Off: No function
1	JOG	Used as JOG operation key and is only enabled when running command is given via operation panel. In stop status, press M key to enter jog operation status, and release this key to stop.	On: Press M Off: Release M to finish the jog operation
2	Emergent stop 1 (Stop in shortest time)	Press M key, inverter will stop in shortest time.	On: Press M Off: Release M
3	Emergent stop 2 (Coast to stop)	Press M key, inverter will coast to stop	On: Press M Off: Release M
4	Switch the reference method of running command	Press M key to switch the reference method of giving running command: Via operation panel→Via terminal→Via host computer→Via operation panel. During switching time, there is a 5-second response time limit and the change is cancelled automatically after 5-second time is exceeded. Within 5s, press PRG key to confirm the change. MON indicator indicates the method of giving the running command.	On: Press M Off: M key has been released for more than 5s or PRG key has been used to confirm the changing of the method of giving running command
5	Switching between FAST/base menus	Press M key to switch between FAST and bASE menus, operation panel should prompt as FAST and bASE	On: FAST fast menu mode Off: bASE basic menu mode
6	ndFt/bASE menu switching	Press M key to switch between ndFt and base menus, the indications on the operation panel are ndFt and base respectively.	On: ndFt – non-leave-factory value menu mode Off: bASE- basic menu mode
7	LASt/bASE menu switching	Press M key to switch between LASt and bASE menus, the indications on the operation panel are LASt and bASE respectively.	On: LASt- last change menu mode Off: bASE- basic menu mode
8	Menu mode switching	bASE→FAST→ndFt→LASt→bASE	On: non-bASE basic menu mode Off: bASE- basic menu mode

4.4 Menu Style

The menu style is 2-level menu.

4.4.1 Format of First Level Menu

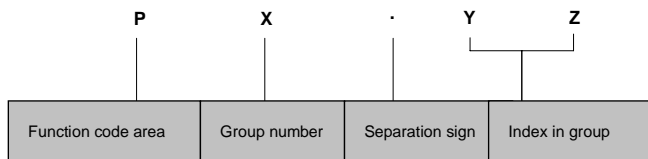

Fig. 4-2 Format of first level menu

◆ Dividing the first level menu

Password action area	Function code area	Group number in area	Function code range
Protection area of user password P0.00	User operation area (P area)	P0 group	P0.00 ~ P0.16
		P1 group	P1.00 ~ P1.08
		P2 group	P2.00 ~ P2.07
		P3 group	P3.00 ~ P3.13
		P4 group	P4.00 ~ P4.36
		P5 group	P5.00 ~ P5.13
		P6 group	P6.00 ~ P6.24
		P7 group	P7.00 ~ P7.25
		P8 group	P8.00 ~ P8.10
		P9 group	P9.00 ~ P9.18
		PA group	PA.00 ~ PA.22
		Pb group	Pb.00 ~ Pb.23
		PC group	PC.00 ~ PC.06
		Pd group	Pd.00 ~ Pd.36
	Equipment status area (d area)	PE group	Reserved
		d0 group	d0.00 ~ d0.11
		d1 group	d1.00 ~ d1.11
		d2 group	d2.00 ~ d2.24
A0.00 protection area	Function code display/hidden area defined by user (A area)	A0 group	A0.00 ~ A0.02
C0.00 reserved area	Reserved (C area)	Reserved parameter area	Reserved
U0.00 reserved area	Reserved (U0 area)	Reserved parameter area	Reserved
U1.00 reserved area	Reserved (U1 area)	Reserved parameter area	Reserved

◆ Structure of first level menu

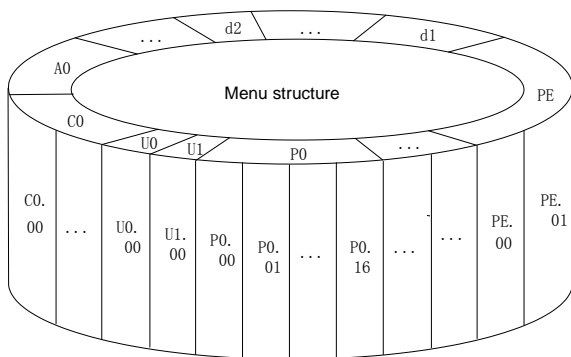

Fig. 4-3 Structure of first level menu

4.4.2 Format of Second Level Menu

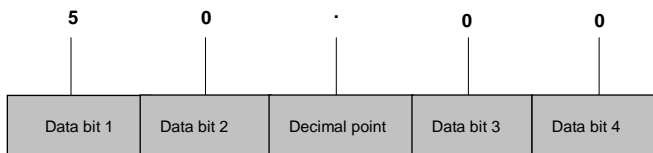

Fig. 4-4 Format of second level menu

◆ Format of display/set for second level menu

Display/set decimal

From data bit 1 to 4, the characters of 0, 1.....9 can be displayed or set.

When displayed data >9999, the last bit will be omitted:

For example: When data is 12345, operation panel displays “1234”.

When data is 1234.5, operation panel displays “1234”.

When data is 123.45, operation panel displays “123.4”.

When data is 12.345, operation panel displays “12.34”.

Display/set hex code:

From data bit 1 to 4, the characters of 0, 1.....9, A, B, C, D, E and F can be displayed or set.

◆ Meanings of 0. 0. 0. 0. displayed in second level menu

After entering second level menu, besides the displayed data, there are also 4 dots, this means the password protection and you need to enter the password. The function codes that needs password input are P0.00, PE.00, A0.00, C0.00, U0.00 and U1.00. PE area, C area, U0 area and U1 area are factory reserved parameter area.

4.4.3 Menu Mode

Menu mode setting (P0.02)	Menu mode name	Visible function code range	Operation panel display
0	Basic menu	See 5.1 for the table of basic menu function code parameter	bASt
1	Fast menu	Quickly display the menu function codes in common use	FASt
2	Non-leave-factory value function code menu	Only display the function codes different from the leave-factory values	ndFt
3	Menu of last changed 10 function codes	Display the last changed 10 function codes and P0.02	LASt

◆ Basic menu bASt

Basic menu includes all the function codes mentioned in this user manual. Except for the special descriptions, all the descriptions of this manual are in this menu mode. See 5.1 for the table of basic menu function code parameter.

◆ Fast menu FASt

Fast menu includes some common function codes and you can start the inverter by setting only a few function codes so as to realize the fast application. See 5.2 for the table of fast menu function code parameter.

◆ Non-leave-factory value function code menu ndFt

This menu mode is used to search for the function codes different from the leave-factory values for the convenience of understanding the parameter setting.

◆ Menu of last changed 10 function codes LASt

If this menu mode is set, it enters password protection status. Only P0.00 and C0.00 can be viewed. The recently changed function codes, P0.00 and P0.02 can be viewed only when correct password is entered into P0.00.

◆ Method of back to basic menu

1. By editing the function code: Set P0.02=0, then the menu returns to basic menu mode after bASt is displayed.
2. By using **M** key: Define the function of multi-function key **M** as menu switching function, then press this key to switch the menu mode. Refer to table 4-1 for the using method of multi-function key and the meanings of MULTI indicator.
3. By pressing **ESC** for a long time: Press **ESC** and do not release it for more than 5s, then the menu returns to basic menu mode after bASt is displayed. If bASt is not displayed, this means the menu is already in basic menu mode.

4.4.4 Common Characters Displayed by LED

Except the function codes in first and second level menus, the operation panel will also display the following characters as shown in the following table:

Prompt symbol	Meaning	Prompt symbol	Meaning
8.8.8.8.	Instantaneous display of inverter when inverter is powered on	LoAd	Inverter parameters are being copied and this symbol will be displayed when parameters are uploaded to operation panel. For example, set Pb.23=1
-LU-	Inverter power off under voltage	Loc1	Operation panel is locked and the keys are disabled
-dc-	Inverter is in DC braking status	Loc2	Except M key, other keys are locked
-At-	Inverter is in auto tuning	Loc3	Except RUN and STOP/RST keys, other keys are locked
bASE	Basic menu (P0.02=0)	ndFt	Non factory setting of function code (P0.02=2)
CoPy	Inverter parameters are being downloaded and this symbol will be displayed when parameters are downloaded to inverter. For example, set Pb.23=2 or 3	P.CLr	Password is cleared, see 4.5 for password operation
dEft	Restore to factory settings (P0.01=2 to 5)	P.SET	Password is set successfully, see 4.5 for password operation
E.XXX	E. means fault or alarm happens. Analysis the fault or alarm according to the fault or alarm list in 7.1	Prot	Password protection is enabled, see 4.6 for key locking and unlocking
FASt	Fast menu (P0.02=1)	SLId	Operation panel is identified as shuttle type
HoLd	The parameter copy or upload function of operation panel is disabled	ULoc	Press ESC+>>+V together to unlock the panel
LASt	10 function codes modified recently (P0.02=3)	UpDn	Operation panel is identified as key type.
LInE	Communication of operation panel fails		

If the symbol is not listed in the table, please contact the local distributor or our company directly.

4.4.5 Identify Symbols Displayed Via LED

The relationship between characters displayed by LED and characters/numbers are as follows:

LED display	Meanings of characters	LED display	Meanings of characters	LED display	Meanings of characters	LED display	Meanings of characters
	0		A		I		S
	1		b		J		T
	2		C		L		t
	3		c		N		U
	4		d		n		V
	5		E		O		y
	6		F		o		-
	7		G		P		8.
	8		H		q		.
	9		h		r		

4.5 Password Operation

- **Set Password**

Enter password function code and set to the identical parameters for two times continuously. After "P.Set" is displayed, the password setting is successful. See 4.8.3 for password setting.

- **Password Verification**

Enter password function code, enter password correctly and you can see the parameters protected by password. See 4.8.4 descriptions of password verification.

- **Clear Password**

After passing password verification, enter password function code, set 0000 continuously for two times, "P. CLr" is displayed, this means the password is successfully cleared. From now on, you need not enter password for access the password protection area. See 4.8.5 descriptions of clearing password.

- **Method of Enabling Password**

One of following three modes can be selected:

1. Press ESC+PRG +▲ at the same time (for shuttle type, turning close wise is equivalent to the ▲ key) to display "Prot". If key locking function is enabled, "Loc1" (P2.00=1) or

"Loc2"(P2.00=2) or "Loc3"(P2.00=3) is displayed.

2. No key operation for continuous 5 minutes.
3. Power on again

4.6 Lock/Unlock Keys

■ Lock Keys

- ◆ Set the function of locking keys

Select the P2.00 key locking functions:

- 0: Do not lock the keys on the operation panel and all the keys can be used;
- 1: Lock the keys on the operation panel and all the keys cannot be used;
- 2: Except multi-function key **M**, all the keys cannot be used;
- 3: Except **RUN** and **STOP/RST** keys, all the keys cannot be used.

- ◆ Key Locking Function is Enabled

One of following three modes can be selected:

1. Press **ESC+PRG +▲** at the same time (for shuttle type, turning close wise is equivalent to the **▲** key) to display "Loc1" (P2.00=1) or "Loc2"(P2.00=2) or "Loc3"(P2.00=3), the operation panel is locked according to the setting method of P2.00. When P2.00=0, "Prot" is displayed and the operation panel is not locked and only the password protection is enabled.
2. Power on the inverter again to lock the operation panel.
3. If there is no key operation within 5 minutes after setting the function code, the operation panel is locked automatically.

■ Unlock Keys:

Press **ESC+>>+▼** keys at the same time (for shuttle type, turning anti-close wise is equivalent to **▼** key) to unlock.

4.7 Operation Panel Display and Key Operation

4.7.1 Classification of Display Status

There are 8 types of display status of operation panel:

SN	Status	Meaning
1	Display status of stopping parameters	Press >> key to switch the displayed parameters, P2.03 can be used to set the displayed parameters.
2	Display status of running parameters	Press >> key to switch the displayed parameters, P2.02 can be used to set the displayed parameters.
3	Display status of fault and alarm	In other 7 kinds of display status, if there is any fault happens, directly enter this status.
4	Display status of first level menu	When the keys are not locked, in status of SN1, SN2, SN3 and SN7, press PRG to enter.
5	Display status of second level menu	In the display status of first level menu, press PRG to enter.
6	Password verification status	If password protection is enabled, press PRG to enter in the display status of first level menu.
7	Password modification status	In the display status of stopping and running parameters, press ▲ and ▼ to enter.
8	Information prompt status	See 4.4.5 for identifying the LED display characters.

4.7.2 Display Status and Operation Process

◆ **>>** key

In the display status of first level menu, press **>>** key to select the edit bit of function code PX.YZ.

In second level menu or password verification status, press **>>** key to select the data edit bit.

◆ Auto switch between status

If no key is operated for 30s, the screen automatically returns to the display status of stopping parameters, or the display status of running parameters.

If no key is operated for 1 minute, clear menu edit status of PX.YZ to return to P0.00.

If there is password setting or key locking setting, if no key is operated for 5 minutes, enter password protection or operation panel locking status automatically.

◆ Display Status and Operation Procedure

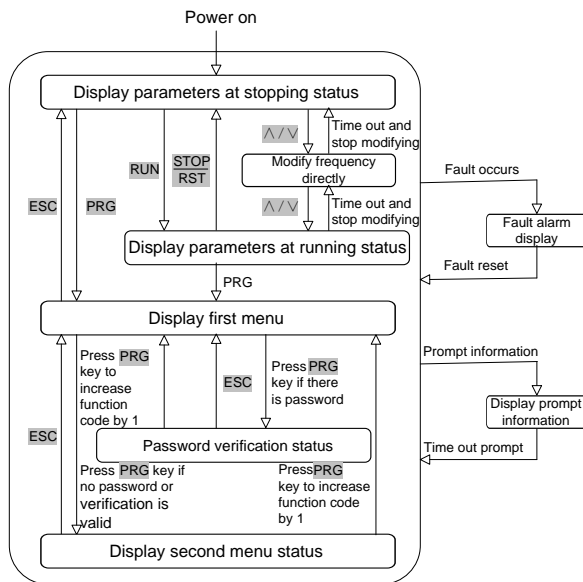

Fig. 4-5 Display status and operation procedure

4.8 Operation Example

In following example, the displayed parameters at stopping status is reference frequency, the factory setting is 50.00Hz. The underscored line in the figure means the bit that is being edited.

4.8.1 Restore Factory Setting

For example, setting P0.01=3: Restore all the parameters in P area to factory settings except the motor parameters (F9 group).

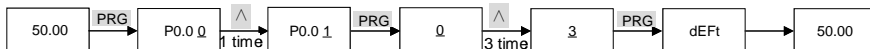

4.8.2 Setting Frequency

For example, setting P0.05=25.00Hz.

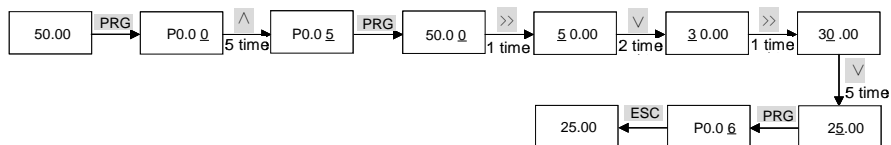

4.8.3 Setting Password

For example, setting user password P0.00 to 0003.

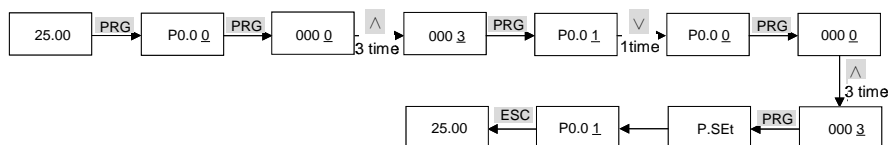

4.8.4 Password Verification

Assume that the function codes after P0.00 are protected by password and the password is 3. If the password protection is not enabled, you can press **ESC+PRG+^** to enable the password in last example of P0.00. You can perform the password verification according to the following process:

Note: If you use RS 485 communication mode to perform password verification, please refer to the Appendix A. The description of register 0xF000 in Modbus communication protocol.



4.8.5 Clear Password

For example, clear the user password P0.00.

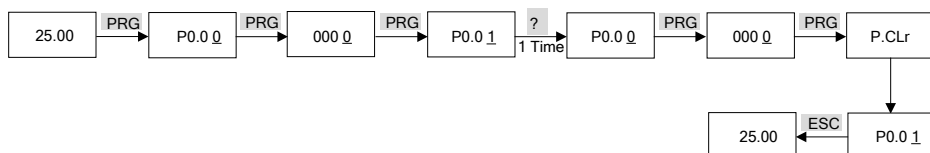

4.9 Running for the First Time

Please follow the procedures to run the inverter for the first time:

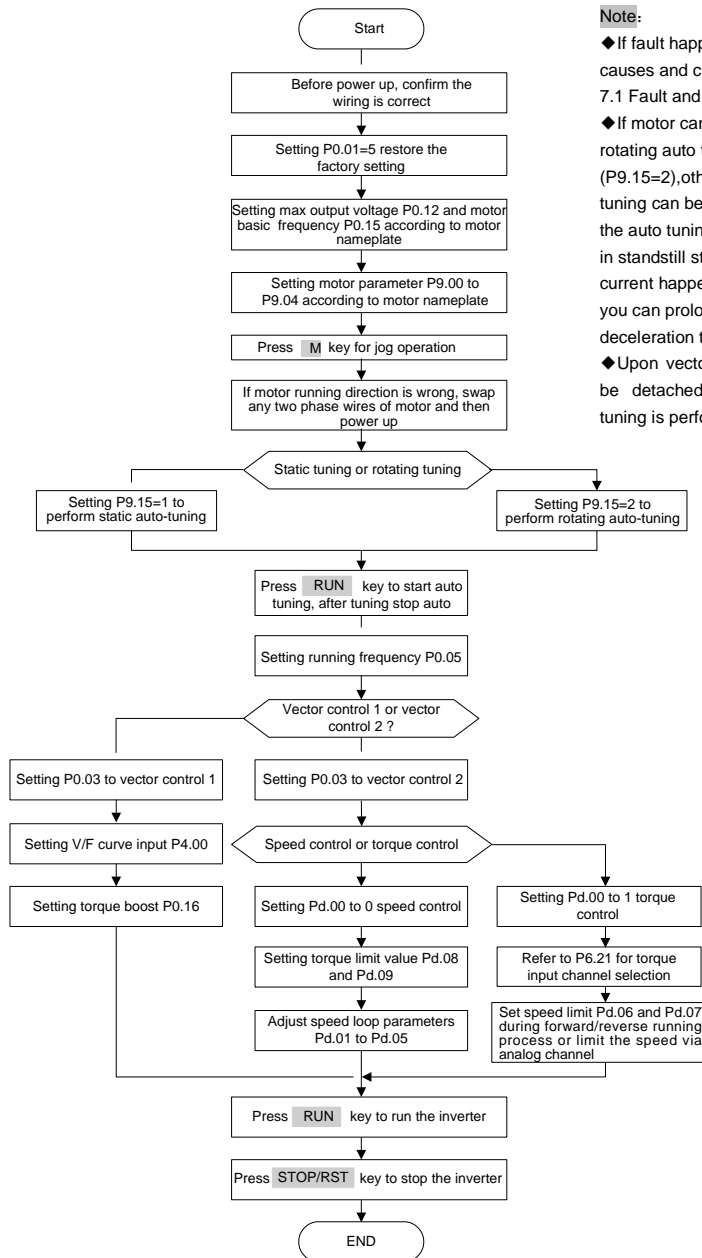

Note:

- ◆ If fault happens, please judge the fault causes and clear the fault according to 7.1 Fault and alarm information list.
- ◆ If motor can without connecting the load rotating auto tuning can be selected (P9.15=2), otherwise only static auto tuning can be selected. When enabling the auto tuning please ensure the motor is in standstill status. If over voltage or over current happens in auto tuning process, you can prolong the acceleration and deceleration times of P0.08 and P0.09.
- ◆ Upon vector control 2, the loads must be detached before the rotating auto tuning is performed.

Chapter 5 List of Parameters

Meanings of Each Item in Function Code Parameter Table

Item	Meanings
Function code number	The number of function code, such as P0.00
Function code name	The name of function code, which explains the function code's meanings.
Factory setting	Restore the settings of the function code after the product is delivered (see P0.01).
Setting range	The value from minimum value to maximum value that can be set to this function code.
Unit	V: Voltage; A: Current; °C: Celsius degree; Ω: Ohm; mH: Milli-henry; rpm: Rotating speed; %: Percentage; bps: baud rate; Hz, kHz: Frequency; ms, s, min, h, kh: Time; kW: Power; /: No unit
Property	○: This function code can be changed during operation; ×: This function code can only be changed during stopping status; *: The setting of this function code is read-only and cannot be changed.
Function code selection	Function code parameter setting list
User setting	Used for recording parameters by user

5.1 List of Basic Menu Function Codes

Function code number	Function code name	Factory setting	Setting range	Unit	Property	Function code selection	User setting
Group P0 Basic Function Parameter							
P0.00	User password	0000	0 ~FFFF	/	○	0000: No password; Other: Password protection	
P0.01	Function code protection	0	0 ~ 5	/	×	0: All the parameters can be modified; 1: All the parameters cannot be modified; 2: Restore parameters in zone P to factory settings; 3: Restore parameters in zone P to factory settings; (except for P9 group) 4: Recover the parameters in zone P and zone A to factory settings; 5: Recover all the parameters to factory settings. (except for d group)	
P0.02	Function code display	0	0 ~ 3	/	○	0: Basic menu mode 1: Fast menu mode 2: Menu mode of non-leave-factory setting value function codes; 3: Menu mode of last changed 10 function codes;	
P0.03	Control operation mode	0	0 ~ 8	/	×	Vector control 1 without encoder speed feedback: 0: Process open loop control; 1: Analog value feedback process close loop control; 2: Single phase pulse feedback	

Function code number	Function code name	Factory setting	Setting range	Unit	Property	Function code selection	User setting
						process close loop control; 3: Composite control; Vector control 2 without encoder speed feedback: 4: Process open loop control 5: Analog value feedback process close loop control; 6: Single phase pulse feedback process close loop control; 7: Composite control; Vector control 2 with encoder speed feedback: 8: Process open loop control	
P0.04	Open loop main reference mode	0	0 ~ 4	/	x	0: Open loop digital frequency reference (P0.05); 1: AI1 analog value reference; 2: AI2 analog value reference; 3: AI3 analog value reference; 4: DI pulse reference	
P0.05	Open loop digital frequency reference	50.00	0.00 ~ 300.00	Hz	o	Upper / lower frequency limit (P0.13 ~ P0.14)	
P0.06	Running command reference mode	0	0 ~ 2	/	o	0: Operation panel; 1: Terminal; 2: Host computer	
P0.07	Running direction command	0	0 ~ 1	/	o	0: Run forward; 1: Run reverse	
P0.08	Acceleration time 0	6.0	0.1 ~ 3600.0	s	o	15kW and below	0.1 ~ 3600.0s
P0.09	Deceleration time 0	20.0				18.5kW and above	
P0.10	S-curve time	0.0	0.0 ~ 3600.0	s	o	0.0 ~ 3600.0s	
P0.11	Maximum output frequency	50.00	0.01 ~ 300.00	Hz	x	Upper frequency limit P0.13 ~ 300.00Hz	
P0.12	Maximum output voltage	380	1 ~ 480	V	x	1 ~ 480V	
P0.13	Frequency upper limit	50.00	0.00 ~ 300.00	Hz	x	Lower frequency limit P0.14 ~ Maximum output frequency P0.11	
P0.14	Frequency lower limit	0.00	0.00 ~ 300.00	Hz	x	0.00Hz ~ Upper frequency limit P0.13	
P0.15	Basic operating frequency	50.00	0.00 ~ 300.00	Hz	x	0.00Hz ~ Maximum output frequency P0.11	
P0.16	Torque boost	0.0	0.0 ~ 30.0	%	x	0.0: Auto torque boost; 0.1% ~ 30.0%	
Group P1 Main and Auxiliary Reference Parameter							
P1.00	Open loop auxiliary reference mode	0	0 ~ 4	/	x	0: None 1: AI1; 2: AI2; 3: AI3; 4: DI	
P1.01	Open loop reference main and auxiliary relation calculation	0	0 ~ 5	/	x	0: Main + Auxiliary; 1: Main - Auxiliary; 2: Auxiliary-50%; 3: Main + Auxiliary-50%; 4: Take maximum value; 5: Take minimum value	
P1.02	Analog feedback close loop control main reference mode	0	0 ~ 4	/	x	0: Digital voltage reference P8.00; 1: AI1; 2: AI2; 3: AI3; 4: DI	
P1.03	Analog feedback close loop control auxiliary reference mode	0	0 ~ 4	/	x	0: None; 1: AI1; 2: AI2; 3: AI3; 4: DI	

Function code number	Function code name	Factory setting	Setting range	Unit	Property	Function code selection	User setting
P1.04	Analog feedback close loop control reference main and auxiliary calculation	0	0 ~ 5	/	x	0: Main + Auxiliary; 1: Main – Auxiliary; 2: Auxiliary–50%; 3: Main + Auxiliary–50%; 4: Take maximum value; 5: Take minimum value	
P1.05	Analog feedback close loop control main feedback mode	1	1 ~ 4	/	x	1: AI1; 2: AI2; 3: AI3; 4: DI	
P1.06	Analog feedback close loop control auxiliary feedback mode	0	0 ~ 4	/	x	0: None; 1: AI1; 2: AI2; 3: AI3; 4: DI	
P1.07	Analog feedback close loop control feedback main and auxiliary calculation	0	0 ~ 5	/	x	0: Main + Auxiliary; 1: Main – Auxiliary; 2: Auxiliary–50%; 3: Main + Auxiliary–50%; 4: Take maximum value; 5: Take minimum value	
P1.08	Process open loop and close loop composite operation relationship calculation	0	0 ~ 1	/	x	0: Open loop frequency reference+ frequency after closed loop PDI adjustment; 1: Open loop frequency reference – frequency after closed loop PDI adjustment	
Group P2 Key and Display Parameters							
P2.00	Key–lock function selection	0	0 ~ 3	/	o	0: No locking; 1: Locking all keys; 2: Locking all keys except MULTI key; 3: Locking all keys except RUN and STOP/RST keys	
P2.01	Multi–function key definition	1	0 ~ 8	/	o	0: No function; 1: Jog function; 2: Emergent shutdown 1(Stop in shortest time); 3: Emergent shutdown 2 (Coast–to–stop); 4: Switch of input method of running command (Operation panel/Terminal/Host computer); 5: Function code display switch (fast/all); 6: Function code display switching (different from leave–factory/all); 7: Function code display switching (the last changed 10 function codes/all); 8: Function code display switching (P0.02 menu mode switching)	

Function code number	Function code name	Factory setting	Setting range	Unit	Property	Function code selection	User setting
P2.02	Display parameter selection at running	1CB0	0 ~ FFFF	/	○	LED ones place: 0: Reference frequency (Hz); 1: Bus voltage (V); 2: AI1(V); 3: AI2(V); 4: AI3(V); 5: DI (%); 6: External counting; 7: Motor rotation speed (rpm); 8: Close loop reference (%); 9: Close loop feedback (%); A: Reference torque (%); B: Running frequency (Hz); C: Output current (A); D: Output torque (%); E: Output power (kW); F: Output voltage (V); LED tens, hundreds, thousands place: Same with above	
P2.03	Display parameter selection at stopping	3210	0 ~ FFFF	/	○	LED ones place: 0: Reference frequency (Hz); 1: Bus voltage (V); 2: AI1(V); 3: AI2(V); 4: AI3(V); 5: DI (%); 6: External counting; 7: Motor rotation speed (rpm); 8: Close loop reference (%); 9: Close loop feedback (%); A: Reference torque (%); B: Reserved; C: Reserved; D: Reserved; E: Reserved; F: Reserved; LED tens, hundreds, thousands place: Same with above	
P2.04	Running proportion display benchmark	0	0 ~ F	/	○	0 ~ F	
P2.05	Running proportion display coefficient	0.0	0.0 ~ 1000.0	%	○	0 ~ 1000.0%	
P2.06	Stopping proportion display benchmark	0	0 ~ F	/	○	0 ~ F	
P2.07	Stopping proportion display coefficient	0.0	0.0 ~ 1000.0	%	○	0 ~ 1000.0%	
Group P3 Start/stop Parameter							
P3.00	Startup mode	0	0 ~ 2	/	×	0: Normal startup; 1: Start after DC injection; 2: Flying startup	
P3.01	DC injection current	0.0	0.0 ~ 120.0	%	×	Constant torque: 0.0 ~ 120.0% inverter rated current Variable torque: 0.0 ~ 90.0% inverter rated current	
P3.02	DC injection time	0.00	0.00 ~ 30.00	s	×	0.00 ~ 30.00s	
P3.03	Startup frequency	0.00	0.00 ~ 60.00	Hz	×	Vector control 2 with encoder speed feedback	0.00 ~frequency upper limit the lower of P0.13 and 60.00Hz
		0.50				Other control mode	
P3.04	Startup frequency retention time	0.0	0.0 ~ 3600.0	s	×	0.0 ~ 3600.0s	

Function code number	Function code name	Factory setting	Setting range	Unit	Property	Function code selection	User setting
P3.05	Stop mode	0	0 ~ 2	/	x	0: Deceleration to stop; 1: Coast to stop; 2: Deceleration to stop+DC braking	
P3.06	DC braking initial frequency	0.00	0.00 ~ 300.00	Hz	x	0.00 ~ 300.00Hz	
P3.07	DC braking current	0.0	0.0 ~ 120.0	%	x	Constant torque: 0.0 ~ 120.0% inverter rated current Variable torque: 0.0 ~ 90.0% inverter rated current	
P3.08	DC braking time	0.00	0.00~ 30.00	s	x	0.00~ 30.00s	
P3.09	Anti-reverse selection	1	0 ~ 1	/	x	0: Run reverse enabled; 1: Run reverse disabled	
P3.10	Forward / reverse dead zone time	0.0	0.0 ~ 3600.0	s	x	0.0 ~ 3600.0s	
P3.11	Jog frequency	5.00	0.10 ~ 300.00	Hz	x	0.10 ~ 300.00Hz	
P3.12	Jog acceleration time	6.0	0.1 ~ 60.0	s	x	0.1 ~ 60.0s	
P3.13	Jog deceleration time	6.0	0.1 ~ 60.0	s	x	0.1 ~ 60.0s	
Group P4 Multi-section Parameter							
P4.00	V/F curve reference	0	0 ~ 6	/	x	0: Direct line; 1: Multi-section (P4.01 ~ P4.08); 2: Power of 1.2; 3: Power of 1.4; 4: Power of 1.6; 5: Power of 1.8; 6: Power of 2	
P4.01	V/F frequency value F0	0.00	0.00 ~ 300.00	Hz	x	F0<F1	
P4.02	V/F voltage value V0	0.0	0.0 ~ 100.0	%	x	0.0 ~ 100.0%	
P4.03	V/F frequency value F1	0.00	0.00 ~ 300.00	Hz	x	F1<F2	
P4.04	V/F voltage value V1	0.0	0.0 ~ 100.0	%	x	0.0 ~ 100.0%	
P4.05	V/F frequency value F2	0.00	0.00 ~ 300.00	Hz	x	F2<F3	
P4.06	V/F voltage value V2	0.0	0.0 ~ 100.0	%	x	0.0 ~ 100.0%	
P4.07	V/F frequency value F3	0.00	0.00 ~ 300.00	Hz	x	F3≤Motor basic frequency P0.15	
P4.08	V/F voltage value V3	0.0	0.0 ~ 100.0	%	x	0.0 ~ 100.0%	
P4.09	Acceleration time 1	20.0	0.1 ~ 3600.0	s	x	0.1 ~ 3600.0s	
P4.10	Deceleration time 1	20.0	0.1 ~ 3600.0	s	x	0.1 ~ 3600.0s	
P4.11	Acceleration time 2	20.0	0.1 ~ 3600.0	s	x	0.1 ~ 3600.0s	
P4.12	Deceleration time 2	20.0	0.1 ~ 3600.0	s	x	0.1 ~ 3600.0s	
P4.13	Acceleration time 3	20.0	0.1 ~ 3600.0	s	x	0.1 ~ 3600.0s	
P4.14	Deceleration time 3	20.0	0.1 ~ 3600.0	s	x	0.1 ~ 3600.0s	
P4.15	Multi-section digital voltage reference 1	1.00	0.00 ~ 10.00	V	o	0.00 ~ 10.00V	
P4.16	Multi-section digital voltage reference 2	2.00	0.00 ~ 10.00	V	o	0.00 ~ 10.00V	
P4.17	Multi-section digital voltage reference 3	3.00	0.00 ~ 10.00	V	o	0.00 ~ 10.00V	
P4.18	Multi-section digital voltage reference 4	5.00	0.00 ~ 10.00	V	o	0.00 ~ 10.00V	
P4.19	Multi-section digital voltage reference 5	6.00	0.00 ~ 10.00	V	o	0.00 ~ 10.00V	
P4.20	Multi-section digital voltage reference 6	8.00	0.00 ~ 10.00	V	o	0.00 ~ 10.00V	

Function code number	Function code name	Factory setting	Setting range	Unit	Property	Function code selection	User setting
P4.21	Multi-section digital voltage reference 7	10.00	0.00 ~ 10.00	V	○	0.00 ~ 10.00V	
P4.22	Multi-section frequency 1	5.00	0.00 ~ 300.00	Hz	○	Upper / lower frequency limit (P0.13 ~ P0.14)	
P4.23	Multi-section frequency 2	8.00	0.00 ~ 300.00	Hz	○	Upper / lower frequency limit (P0.13 ~ P0.14)	
P4.24	Multi-section frequency 3	10.00	0.00 ~ 300.00	Hz	○	Upper / lower frequency limit (P0.13 ~ P0.14)	
P4.25	Multi-section frequency 4	15.00	0.00 ~ 300.00	Hz	○	Upper / lower frequency limit (P0.13 ~ P0.14)	
P4.26	Multi-section frequency 5	18.00	0.00 ~ 300.00	Hz	○	Upper / lower frequency limit (P0.13 ~ P0.14)	
P4.27	Multi-section frequency 6	20.00	0.00 ~ 300.00	Hz	○	Upper / lower frequency limit (P0.13 ~ P0.14)	
P4.28	Multi-section frequency 7	25.00	0.00 ~ 300.00	Hz	○	Upper / lower frequency limit (P0.13 ~ P0.14)	
P4.29	Multi-section frequency 8	28.00	0.00 ~ 300.00	Hz	○	Upper / lower frequency limit (P0.13 ~ P0.14)	
P4.30	Multi-section frequency 9	30.00	0.00 ~ 300.00	Hz	○	Upper / lower frequency limit (P0.13 ~ P0.14)	
P4.31	Multi-section frequency 10	35.00	0.00 ~ 300.00	Hz	○	Upper / lower frequency limit (P0.13 ~ P0.14)	
P4.32	Multi-section frequency 11	38.00	0.00 ~ 300.00	Hz	○	Upper / lower frequency limit (P0.13 ~ P0.14)	
P4.33	Multi-section frequency 12	40.00	0.00 ~ 300.00	Hz	○	Upper / lower frequency limit (P0.13 ~ P0.14)	
P4.34	Multi-section frequency 13	45.00	0.00 ~ 300.00	Hz	○	Upper / lower frequency limit (P0.13 ~ P0.14)	
P4.35	Multi-section frequency 14	48.00	0.00 ~ 300.00	Hz	○	Upper / lower frequency limit (P0.13 ~ P0.14)	
P4.36	Multi-section frequency 15	50.00	0.00 ~ 300.00	Hz	○	Upper / lower frequency limit (P0.13 ~ P0.14)	
Group P5 Multi-functional Input Parameter							
P5.00	X1 terminal input function selection	99	0 ~ 99	/	×	Refer to Definition of multi function input terminals of P5 group in Chapter 6	
P5.01	X2 terminal input function selection	99	0 ~ 99	/	×		
P5.02	X3 terminal input function selection	99	0 ~ 99	/	×		
P5.03	X4 terminal input function selection	99	0 ~ 99	/	×		
P5.04	X5 terminal input function selection	99	0 ~ 99	/	×		
P5.05	X6 terminal input function selection	99	0 ~ 99	/	×		
P5.06	X7/D1 terminal input function selection	99	0 ~ 99	/	×		
P5.07	X1 to X7 terminal filtering time	0.001	0.000 ~ 1.000	s	×	0.000 ~ 1.000s	
P5.10	Maximum input pulse frequency	10.0	0.1 ~ 50.0	kHz	×	0.1 ~ 50.0kHz	
P5.11	Startup/stop mode selection	0	0 ~ 3	/	×	0: 2-wire type 1;1: 2-wire type 2; 2: 3-wire type 1;3: 3-wire type 2;	
P5.12	Preset counting value reference	0	0 ~ 9999	/	×	0 ~ 9999	
P5.13	Reached counting value reference	0	0 ~ 9999	/	×	0 ~ 9999	

Function code number	Function code name	Factory setting	Setting range	Unit	Property	Function code selection	User setting
Group P6 Analog Reference Parameter							
P6.00	A11 to A13 and DI analog value input curve selection	4444	0 ~ 4444	/	○	LED ones place: A11 0: Determine the reference frequency according to curve 1(P6.01 ~ P6.04); 1: Determine the reference frequency according to curve 1(P6.05 ~ P6.08); 2: Determine the per unit value determined according to curve 3 (P6.09 to P6.12); 3: Determine the per unit value determined according to curve 4 (P6.13 to P6.20); 4: No need of curve correction LED tens place: A12, same with above LED hundreds place: A13, same with above LED thousands place: DI, same with above	
P6.01	Curve 1 input point A0	0.0	0.0 ~ 110.0	%	○	0.0 ~ 110.0%	
P6.02	Reference frequency f0 corresponding to curve1 input point A0	0.00	0.00 ~ 300.00	Hz	○	0.00 ~ 300.00Hz	
P6.03	Curve 1 input point A1	100.0	0.0 ~ 110.0	%	○	0.0 ~ 110.0%	
P6.04	Reference frequency f1 corresponding to curve1 input point A1	50.00	0.00 ~ 300.00	Hz	○	0.00 ~ 300.00Hz	
P6.05	Curve2 input point A0	0.0	0.0 ~ 110.0	%	○	0.0 ~ 110.0%	
P6.06	Reference frequency f0 corresponding to curve2 input point A0	0.00	0.00 ~ 300.00	Hz	○	0.00 ~ 300.00Hz	
P6.07	Curve2 input point A1	100.0	0.0 ~ 110.0	%	○	0.0 ~ 110.0%	
P6.08	Reference frequency f1 corresponding to curve2 input point A1	50.00	0.00 ~ 300.00	Hz	○	0.00 ~ 300.00Hz	
P6.09	Curve3 input point A0	0.0	0.0 ~ 110.0	%	○	0.0~110.0%	
P6.10	Per-unit value B0 corresponding to curve3 input point A0	0.0	0.0 ~ 110.0	%	○	0.0~110.0%	
P6.11	Curve3 input point A1	100.0	0.0 ~ 110.0	%	○	0.0~110.0%	

Function code number	Function code name	Factory setting	Setting range	Unit	Property	Function code selection	User setting
P6.12	Per-unit value B1 corresponding to curve3 input point A1	100.0	0.0 ~ 110.0	%	○	0.0~110.0%	
P6.13	Curve4 input point A0	0.0	0.0 ~ 110.0	%	○	0.0~110.0%	
P6.14	Per-unit value B0 corresponding to curve4 input point A0	0.0	0.0 ~ 110.0	%	○	0.0~110.0%	
P6.15	Curve4 input point A1	25.0	0.0 ~ 110.0	%	○	0.0~110.0%	
P6.16	Per-unit value B1 corresponding to curve4 input point A1	25.0	0.0 ~ 110.0	%	○	0.0~110.0%	
P6.17	Curve4 input point A2	50.0	0.0 ~ 110.0	%	○	0.0~110.0%	
P6.18	Per-unit value B2 corresponding to curve4 input point A2	50.0	0.0 ~ 110.0	%	○	0.0~110.0%	
P6.19	Curve4 input point A3	100.0	0.0 ~ 110.0	%	○	0.0~110.0%	
P6.20	Per-unit value B23 corresponding to curve4 input point A3	100.0	0.0 ~ 110.0	%	○	0.0~110.0%	
P6.21	A11~A13. DI analog channel function selection	0000	0 ~ 6666	/	×	LED ones place: A11 function selection 0: Open loop frequency or close loop analog input; 1: Torque reference 1 (torque control operation mode); 2: Torque reference 2 (torque control operation mode); 3: Reserved; 4: Reserved; 5: Motor temperature feedback (overload protective sensor); 6: Speed limiting (torque control operation mode); LED tens place: A12 function selection, same with above LED hundreds place: A13 function selection, same with above LED thousands place: DI function selection, same with above	
P6.22	A11 filtering time	0.004	0.000 ~ 1.000	s	×	0.000 ~ 1.000s	
P6.23	A12 filtering time	0.004	0.000 ~ 1.000	s	×	0.000 ~ 1.000s	
P6.24	A13 filtering time	0.004	0.000 ~ 1.000	s	×	0.000 ~ 1.000s	
Group P7 Multi-function Output Parameter							
P7.00	Y1 terminal output function selection	0	0 ~ 47	/	○	Refer to the definitions of multi function digital outputs of P7 group, and the definitions of multi function analog values and pulse output in Chapter 6.	
P7.01	Y2/DO terminal output function selection	1	0 ~ 71	/	○		

Function code number	Function code name	Factory setting	Setting range	Unit	Property	Function code selection	User setting
P7.02	Relay terminal output function selection	14	0 ~ 47	/	○		
P7.03	AO1 terminal output function selection	48	48 ~ 71	/	○		
P7.04	AO2 terminal output function selection	49	48 ~ 71	/	○		
P7.05	AO1 gain	100.0	0.0 ~ 200.0	%	○	0.0 ~ 200.0%	
P7.06	AO1 bias	0.0	0.0 ~ 200.0	%	○	0.0 ~ 200.0%	
P7.07	AO2 gain	100.0	0.0 ~ 200.0	%	○	0.0 ~ 200.0%	
P7.08	AO2 bias	0.0	0.0 ~ 200.0	%	○	0.0 ~ 200.0%	
P7.09	Selection of positive and negative gain and bias	0000	0 ~ 1111	/	○	Ones place: AO1 gain: 0: Positive;1: Negative Tens place: AO1 bias: 0: Positive;1: Negative Hundreds place: AO2 gain: 0: Positive;1: Negative Thousands place: AO2 bias: 0: Positive;1: Negative	
P7.10	Y2/DO maximum output pulse frequency selection	10.0	0.1 ~ 50.0	kHz	○	0.1 ~ 50.0kHz	
P7.18	Zero current detection width	0.0	0.0 ~ 50.0	%	○	0.0 ~ 50.0%	
P7.19	Frequency arrival detection width	2.50	0.00 ~ 300.00	Hz	○	0.00 ~ 300.00Hz	
P7.20	FDT1 level upper limit	50.00	0.00 ~ 300.00	Hz	○	0.00 ~ 300.00Hz	
P7.21	FDT1 level lower limit	49.00	0.00 ~ 300.00	Hz	○	0.00 ~ 300.00Hz	
P7.22	FDT2 level upper limit	25.00	0.00 ~ 300.00	Hz	○	0.00 ~ 300.00Hz	
P7.23	FDT2 level lower limit	24.00	0.00 ~ 300.00	Hz	○	0.00 ~ 300.00Hz	
P7.24	Virtual terminal effective selection	000	0 ~ 111	/	○	LED ones place: Multi function input terminal Xi 0: Real terminal is enabled; 1: Virtual terminal is enabled LED tens place: Reserved LED hundreds place: Y1/Y2/Relay terminal 0: Real terminal is enabled; 1: Virtual terminal is enabled	
P7.25	Terminal effective status selection	000	0 ~ 1111	/	○	Ones place: Multi function input terminal Xi 0: Current through Xi is valid; 1: No current through Xi is valid Tens place: Multi function output terminal Yi 0: Current through Yi is valid; 1: No current through Yi is valid Hundreds place: relay terminal 0: Enabled in magnetizing status; 1: Enabled if not in magnetizing status	

Function code number	Function code name	Factory setting	Setting range	Unit	Property	Function code selection	User setting
Group P8 Process PID Close Loop Control							
P8.00	Analog feedback process close loop control digital voltage reference	0.00	0.00 ~ 10.00	V	○	0.00 ~ 10.00V	
P8.01	Single phase pulse feedback process close loop control digital RPM reference	0	0 ~ 30000	rpm	○	0 ~ 30000rpm	
P8.02	Number of pulse per turn for single phase pulse	1000	1 ~ 9999	/	×	1 ~ 9999	
P8.03	Proportional gain KP	0.200	0.000 ~ 10.000	/	○	0.000 ~ 10.000	
P8.04	Integral gain Ki	0.500	0.000 ~ 10.000	/	○	0.000 ~ 10.000	
P8.05	Differential gain Kd	0.000	0.000 ~ 10.000	/	○	0.000 ~ 10.000	
P8.06	Sampling cycle	0.002	0.001 ~ 30.000	s	○	0.001 ~ 30.000s	
P8.07	Deviation limit	5.0	0.0 ~ 20.0	%	○	0.0 ~ 20.0%	
P8.08	PID adjustment selection	10	0 ~ 11	/	○	Ones place: Integral mode 0: Frequency reaches upper/lower limit, stop integral regulation; 1: Frequency reaches upper/lower limit, continue integral regulation Tens place: output frequency 0: Be consistent with preset direction; 1: Reverse to preset direction	
P8.09	PID positive or negative function	0	0 ~ 1	/	○	0 ~ 1	
P8.10	Reserved function code 2 of P8 group	0	0 ~ 65535	/	○	0 ~ 65535	
Group P9 Motor Parameter							
P9.00	Load type	0	0 ~ 1	/	×	0: G type constant torque/ heavy duty application; 1: L type variable torque/ light duty application	
P9.01	Number of motor poles	4	2 ~ 24	/	×	2 ~ 24	
P9.02	Rated rotating velocity of motor	1500	0 ~ 30000	rpm	×	0 ~ 30000rpm	
P9.03	Rated power of motor	11.0	0.4 ~ 999.9	kW	×	0.4 ~ 999.9kW	
P9.04	Rated current of motor	21.7	0.1 ~ 999.9	A	×	0.1 ~ 999.9A	
P9.05	Zero load current I0	8.4	0.1 ~ 999.9	A	×	0.1 ~ 999.9A	
P9.06	Stator resistance R1	0.407	0.000 ~ 65.000	Ω	×	0.000 ~ 65.000Ω	
P9.07	Stator leakage inductance L1	2.6	0.0 ~ 2000.0	mH	×	0.0 ~ 2000.0mH	
P9.08	Rotor resistance R2	0.219	0.000 ~ 65.000	Ω	×	0.000 ~ 65.000Ω	
P9.09	Mutual inductance L2	77.4	0.0 ~ 2000.0	mH	×	0.0 ~ 2000.0mH	
P9.10	Magnetic saturation coefficient 1	87.00	0.00 ~ 100.00	%	×	0.0 ~ 100.00%	
P9.11	Magnetic saturation coefficient 2	80.00	0.00 ~ 100.00	%	×	0.0 ~ 100.00%	

Function code number	Function code name	Factory setting	Setting range	Unit	Property	Function code selection	User setting
P9.12	Magnetic saturation coefficient 3	75.00	0.00 ~ 100.00	%	x	0.0 ~ 100.00%	
P9.13	Magnetic saturation coefficient 4	72.00	0.00 ~ 100.00	%	x	0.0 ~ 100.00%	
P9.14	Magnetic saturation coefficient 5	70.00	0.00 ~ 100.00	%	x	0.0 ~ 100.00%	
P9.15	Parameter auto tuning	0	0 ~ 2	/	x	0: No action; 1: Static auto tuning; 2: Rotating auto tuning	
P9.16	Motor overload protection	00	0 ~ 12	/	x	Ones place: Protection mode; 0: Motor current mode; 1: Sensor mode; 2: No action Tens place: Low speed derating 0: Action(suitable for common motor); 1: No action(suitable for variable frequency motor)	
P9.17	Sensor protection threshold of motor	10.00	0.00 ~ 10.00	V	x	0.00 ~ 10.00V	
P9.18	Motor overload protection time	10.0	0.5 ~ 30.0	min	x	0.5 ~ 30.0min	
Group PA Control Parameter							
PA.00	Carrier frequency	8.0 4.0 3.0 2.0	0.7 ~ 16.0	kHz	o	15kW or below : 0.7kHz ~ 16.0kHz; 18.5kW ~ 45kW: 0.7kHz ~ 10.0kHz; 55kW ~ 75kW: 0.7kHz ~ 8.0kHz; 90kW or above: 0.7kHz ~ 3.0kHz	
PA.01	Carrier frequency automatic adjustment selection	1	0 ~ 1	/	o	0: No auto adjustment; 1: Auto adjustment	
PA.02	Vector control 1 slip compensation gain	100.0	0.0 ~ 300.0	%	o	0.0 ~ 300.0%	
PA.03	Droop control	0.00	0.00 ~ 10.00	Hz	o	0.00 ~ 10.00Hz	
PA.04	Current limit action selection	1	0 ~ 1	/	x	0: Disabled; 1: Enabled	
PA.05	Current limit value	160.0	20.0 ~ 200.0	%	x	Constant torque: 20.0 ~ 200.0% rated current of inverter Variable torque: 20.0 ~ 150.0% rated current of inverter	
PA.06	Voltage adjustment function	101	000 ~ 111	/	x	Ones place: Over voltage regulation 0: Disabled; 1: Enabled Tens place: Under voltage regulation 0: Disabled; 1: Enabled Hundreds place: Over modulation 0: Disabled; 1: Enabled	
PA.07	Energy saving coefficient	0	0 ~ 50	%	o	0 ~ 50%	
PA.08	Magnetic flux braking selection	1	0 ~ 1	/	x	0: Disabled; 1: Enabled	
PA.09	Energy consumption braking selection	0	0 ~ 1	/	x	0: Disabled; 1: Enabled	
PA.10	Braking unit operating time	100.0	100.0	s	x	100.0s(Total cycle working time and interval is 100s)	
PA.11	Braking unit action voltage	720	650 ~ 750	V	x	650 ~ 750V	

Function code number	Function code name	Factory setting	Setting range	Unit	Property	Function code selection	User setting
PA.12	Relay action indication when the inverter is faulty	100	000 ~ 111	/	x	LED ones place: Under volt fault 0: Disabled; 1: Enabled LED tens place: Auto reset interval 0: Disabled; 1: Enabled LED hundreds place: Fault locking 0: Disabled; 1: Enabled	
PA.13	Inverter or motor overload prealarm	000	000 ~ 111	/	x	LED ones place: Selection of detected value 0: Motor overload pre-alarm, relative to motor rated current; 1: Inverter overload pre-alarm, relative to inverter rated current; LED tens place: Action selection after overload pre-alarm 0: Continue running; 1: Report overload fault and stop; LED hundreds place: Detecting condition selection 0: Detect all the time; 1: Only detect at constant speed	
PA.14	Overload pre-alarm detection level	130.0	20.0 ~ 200.0	%	x	20.0 ~ 200.0%	
PA.15	Overload pre-alarm detection time	5.0	0.1 ~ 60.0	s	x	0.1 ~ 60.0s	
PA.16	Fault shield and alarm attribute setting 1	0020	0000 ~ 2222	/	x	LED ones place: Output-ground short circuit LED tens place: Power failure during running process LED hundreds place: Input power error LED thousands place: Output phase failure 0: Fault is not shielded, stopped upon fault; 1: Fault is not shielded, non-stop upon fault; 2: Fault is shielded, no alarm and no stop	
PA.17	Fault shield and alarm attribute setting 2	0000	0000 ~ 2222	/	x	LED ones place: EEPROM error LED tens place: Relay contact open/close failure LED hundreds place: Temperature sampling disconnection LED thousands place: encoder disconnection 0: Fault is not shielded, stopped upon fault; 1: Fault is not shielded, non-stop upon fault; 2: Fault is shielded, no alarm and no stop	

Function code number	Function code name	Factory setting	Setting range	Unit	Property	Function code selection	User setting
PA.18	Fault shield and alarm attribute setting 3	2000	0000 ~ 2222	/	x	LED ones place: +10V output error LED tens place: Analog input error LED hundreds place: Motor over temperature (PTC) LED thousands place: Communication failure 1(operation panel 485) 0: Fault is not shielded, stopped upon fault; 1: Fault is not shielded, non-stop upon fault; 2: Fault is shielded, no alarm and no stop	
PA.19	Fault shield and alarm attribute setting 4	0002	0000 ~ 2222	/	x	LED ones place: Communication failure 2(terminal 485) LED tens place: Version incompatible LED hundreds place: Reserve; LED thousands place: Reserve; 0: Fault is not shielded, stopped upon fault; 1: Fault is not shielded, non-stop upon fault; 2: Fault is shielded, no alarm and no stop	
PA.20	Fault locking function selection	0	0 ~ 1	/	x	0: Fault is not locked; 1: Fault is locked	
PA.21	Automatic reset times	0	0 ~ 20	/	x	0 ~ 20	
PA.22	Automatic reset interval	2.0	2.0 ~20.0	s	x	2.0 ~ 20.0s	
Group Pb Enhanced Function Parameter							
Pb.00	Hopping frequency 1 lower limit	0.00	0.00 ~ 300.00	Hz	x	Upper / lower frequency limit (P0.13 ~ P0.14)	
Pb.01	Hopping frequency 1 upper limit	0.00	0.00 ~ 300.00	Hz	x	Upper / lower frequency limit (P0.13 ~ P0.14)	
Pb.02	Hopping frequency 2 lower limit	0.00	0.00 ~ 300.00	Hz	x	Upper / lower frequency limit (P0.13 ~ P0.14)	
Pb.03	Hopping frequency 2 upper limit	0.00	0.00 ~ 300.00	Hz	x	Upper / lower frequency limit (P0.13 ~ P0.14)	
Pb.04	Hopping frequency 3 lower limit	0.00	0.00 ~ 300.00	Hz	x	Upper / lower frequency limit (P0.13 ~ P0.14)	
Pb.05	Hopping frequency 3 upper limit	0.00	0.00 ~ 300.00	Hz	x	Upper / lower frequency limit (P0.13 ~ P0.14)	
Pb.06	Single step under without integral function	0.1	0.0 ~ 10.00	Hz	o	0.0 ~ 10.00Hz	
Pb.07	Magnification selection	00	00 ~ 11	/	x	Ones place: Acceleration / deceleration time 0: X1; 1: X10 Tens place: Reserved	
Pb.08	Operation panel \wedge/\vee digital regulating frequency control	0001	0000 ~ 1221	/	o	Ones place: Action upon power off 0: Save upon power off; 1: Clear upon power off Tens place: Action upon stopping 0: Hold upon stopping; 1: Clear upon stop;	

Function code number	Function code name	Factory setting	Setting range	Unit	Property	Function code selection	User setting
						2: Clear upon standby Hundreds place: \wedge/\vee setting via operation panel 0: Only enabled when main input is P0.05 open loop digital frequency input; 1: Adjustment is valid; 2: Adjustment is invalid Thousands place: 0: With integral function; 1: Without integral function	
Pb.09	Operation panel \wedge/\vee integral rate	2.0	0.1 ~ 50.0	s	o	0.1 ~ 50.0s	
Pb.10	Terminal UP/DN digital regulating frequency control	0001	0000 ~1221	/	o	Ones place: Action upon power off 0: Save upon power off; 1: Clear upon power off Tens place: Action upon stopping 0: Hold upon stopping; 1: Clear upon stop; 2: Clear upon standby Hundreds place: Terminal UP/DN adjustment setting 0: Only enabled when main input is P0.05 open loop digital frequency input; 1: Adjustment is valid; 2: Adjustment is invalid Thousands place: 0: With integral function; 1: Without integral function	
Pb.11	Terminal UP/DN integral rate	2.0	0.1 ~ 50.0	s	o	0.1 ~ 50.0s	
Pb.15	Restart automatically after power resumes normal	0	0 ~ 1	/	x	0: No action; 1: Action	
Pb.16	Waiting time for restart	0.5	0.0 ~ 20.0	s	o	0.0 ~ 20.0s	
Pb.17	Preset frequency	0.00	0.00 ~ 300.00	Hz	x	0.00 ~ 300.00Hz	
Pb.18	Preset frequency operating time	0.0	0.0 ~ 3600.0	s	x	0.0 ~ 3600.0s	
Pb.19	Upper limit of zero frequency operation	0.00	0.00 ~ 300.00	Hz	x	0.00 ~ 300.00Hz	
Pb.20	Lower limit of zero frequency operation	0.00	0.00 ~ 300.00	Hz	x	0.00 ~ 300.00Hz	
Pb.21	Reserved	0	0 ~ 1	/	x	Reserved	
Pb.22	Reserved	380.0	0.0 ~ 380.0	V	x	Reserved	
Pb.23	Parameter copy	0	0 ~ 5	/	x	0: No function; 1: Parameter uploading; 2: Parameter downloading (without motor parameters); 3: Parameter downloading (with motor parameters); 4: Parameter storage enable (upload is prohibited); 5: Parameter storage disable (upload is allowed)	

Function code number	Function code name	Factory setting	Setting range	Unit	Property	Function code selection	User setting
Group PC Communication Parameters							
PC.00	Communication baud rate	6	4 ~ 8	bps	○	4: 4800 bps; 5: 9600 bps; 6: 19200 bps; 7: 38400 bps; 8: 57600 bps	
PC.01	Data format	0	0 ~ 2	/	○	0: 1-8-1 format, no parity; 1: 1-8-1 format, even parity; 2: 1-8-1 format, odd parity	
PC.02	Local address	1	1 ~ 247	/	○	1 ~ 247, 0 is broadcasting address	
PC.03	PC Reserved 1	0	0 ~ 65535	/	*	Reserved	
PC.04	Master-slave mode	0	0 ~ 2	/	○	0: SCIA slave mode, SCIB slave mode; 1: SCIA master mode, SCIB slave mode; 2: SCIA slave mode, SCIB master mode	
PC.05	Operation address from master to slave (set by master)	0	0 ~ 2	/	○	Master preset frequency written in function code of slave 0: P0.05; 1: P8.00; 2: P8.01;	
PC.06	Slave setting frequency proportional coefficient (set by slave)	1.00	0.00 ~ 10.00	/	○	0.00 ~ 10.00	
Group Pd Vector Control 2 Parameters							
Pd.00	Speed/torque control	0	0 ~ 1	/	○	0: Speed control; 1: Torque control	
Pd.01	Speed loop proportional gain 1 (ASR_P1)	2.00	0.000 ~ 30.00	/	○	Vector control 2 without encoder speed feedback	0.000~30.00 0
		3.00				Vector control 2 with encoder speed feedback	
Pd.02	Speed loop integral time 1 (ASR_I1)	0.200	0.000 ~ 6.000	s	○	0.000 ~ 6.000s	
Pd.03	Speed loop proportional gain 2 (ASR_P2)	2.000	0.000 ~30.00	/	○	Vector control 2 without encoder speed feedback r	0.000~30.00 0
		3.00				Vector control 2 with encoder speed feedback	
Pd.04	Speed loop integral time 2 (ASR_I2)	0.200	0.000 ~ 6.000	s	○	0.000 ~ 6.000s	
Pd.05	ASR switching frequency	5.00	0.00 ~ 300.00	Hz	○	0.00 ~ upper frequency limit P0.13	
Pd.06	Maximum speed limit for forward running when torque control	50.00	0.00 ~ 300.00	Hz	○	0.00 ~ upper frequency limit P0.13	
Pd.07	Maximum speed limit for reverse running when torque control	50.00	0.00 ~ 300.00	Hz	○	0.00 ~ upper frequency limit P0.13	
Pd.08	Drive torque limit	180.0	0.0 ~ 200.0	%	○	Constant torque: 0.0 ~ 200.0% Variable torque: 0.0 ~ 150.0%	
Pd.09	Braking torque limit	180.0	0.0 ~ 200.0	%	○	Constant torque: 0.0 ~ 200.0% Variable torque: 0.0 ~ 150.0%	
Pd.10	Reserved	4	0 ~ 65535	/	○	Reserved	

Function code number	Function code name	Factory setting	Setting range	Unit	Property	Function code selection	User setting
Pd.11	Reserved	0.010	0.000 ~ 65.535	s	○	Reserved	
Pd.12	Torque acceleration time	0.10	0.00 ~ 120.00	s	○	0.00 ~ 120.00s	
Pd.13	Torque deceleration time	0.10	0.00 ~ 120.00	s	○	0.00~120.00s	
Pd.14	Pre-magnetizing time	0.300	0.000 ~ 8.000	s	○	0.000 ~ 8.000s	
Pd.15	Current loop scale coefficient (ACR_P)	1000	0 ~ 2000	/	○	0 ~ 2000	
Pd.16	Current loop integral coefficient (ACR_I)	1000	0 ~ 6000	/	○	0 ~ 6000	
Pd.17	Vector control 2 slip compensation gain (electric)	100.0	10.0 ~ 300.0	%	○	10.0 ~ 300.0%	
Pd.18	Vector control 2 slip compensation gain (power generation)	100.0	10.0~300.0	%	○	10.0 ~ 300.0%	
Pd.19	ASR input filtering time	0.5	0.0~500.0	ms	○	0.0~500.0	
Pd.20	ASR output filtering time	0.5	0.0~500.0	ms	○	0.0~500.0	
Pd.21	Number of pulses per turn for encoder (vector control 2 with encoder speed feedback)	1024	1~9999	/	*	1 to 9999 pulses/turn	
Pd.22	Encoder direction selection	0	0~1	/	*	0: Forward; 1: Reverse	
Pd.23	Interrupt detection time of encoder	2.0	0.0~8.0	S	*	0.0~8.0	
Pd.24	Deceleration ratio between motor and encoder	1.000	0.001~65.535	/	○	0.001~65.535	
Pd.25	Zero servo enable	0	0~1	/	○	0: Zero servo invalid; 1: zero servo valid;	
Pd.26	Zero servo initial frequency	0.30	0.0~10.0	Hz	○	0.0~10.0Hz	
Pd.27	Zero servo gain	1.000	1.000~9.999	/	○	1.000~9.999	
Pd.28	Static friction compensation coefficient	0.0	0.0~200.0	%	○	0.0~200.0%	
Pd.29	Sliding friction compensation coefficient	0.0	0.0~200.0	%	○	0.0~200.0%	
Pd.30	Rotation inertia compensation coefficient	0.0	0.0~200.0	%	○	0.0~200.0%	
Pd.31	Rotation inertia compensation frequency upper limit 1	0.0	0.0~300.0	Hz	○	0.0~300.0Hz	
Pd.32	Rotation inertia compensation frequency upper limit 2	50.00	0.0~300.0	Hz	○	0.0~300.0Hz	
Pd.33	Torque limiting compensation coefficient in constant power zone	40.0	0.0~100.0	%	○	0.0~100.0%	

Function code number	Function code name	Factory setting	Setting range	Unit	Property	Function code selection	User setting
Pd.34	Reserved	28	0-65535	/	o	0-65535	
Pd.35	Reserved	1500	0-65535	/	o	0-65535	
Pd.36	Torque taper	0	0-65535	/	o	0-65535	
Group d0 Fault Record Parameters							
d0.00	Fault type record 2	0	0-62	/	*	Refer to 7.1 fault and alarm information list	
d0.01	Fault type record 1	0	0-62	/	*		
d0.02	Latest fault type record 0	0	0-62	/	*		
d0.03	Bus voltage of latest fault	0	0-999	V	*	0-999V	
d0.04	Actual current of latest fault	0.0	0.0-999.9	A	*	0.0-999.9V	
d0.05	Operation frequency of the latest fault	0.00	0.00-300.00	Hz	*	0.00-300.00Hz	
d0.06	Total power-up time on time	0.000	0.000-65.535	kh	*	0.000-65.535kh	
d0.07	Total operation time of the inverter	0.000	0.000-65.535	kh	*	0.000-65.535kh	
d0.08	Record of maximum temperature of heatsink	0.0	0.0-100.0	°C	*	0.0-100.0°C	
d0.09	Record of maximum bus voltage fluctuation	0	0-1000	V	*	0-1000V	
d0.10	Reserved	0.00	0.00-300.00	Hz	*	0.00-300.00Hz	
d0.11	Reserved	0	0-5	/	*	0-5	
Group d1 Product Identity Parameters							
d1.00	Serial number	Factory	0.0-FFFF	/	*	0 ~ FFFF	
d1.01	Software version number of control board	Factory	0.00-99.99	/	*	0.0-99.99	
d1.02	Non-standard version number of software of control board	Factory	0.00-FF.FF	/	*	0.00-FF.FF	
d1.03	Software version number of operation panel	Factory	0.000-F.FFF	/	*	0.000-F.FFF	
d1.04	Software version number of extension board	Factory		/	*	0.000-F.FFF	
d1.05	Manufacture's bar code 1	Factory	0 ~ 9999	/	*	0 ~ 9999	
d1.06	Manufacture's bar code 2	Factory	0 ~ 9999	/	*	0 ~ 9999	
d1.07	Manufacture's bar code 3	Factory	0 ~ 9999	/	*	0 ~ 9999	
d1.08	Manufacture's bar code 4	Factory	0 ~ 9999	/	*	0 ~ 9999	
d1.09	Operation panel copy identification code	Factory	0.00 ~ 655.35	/	*	0.00 ~ 655.35	
d1.10	Control board software identification code	Factory	0-65535	/	*	0-65535	

Function code number	Function code name	Factory setting	Setting range	Unit	Property	Function code selection	User setting
d1.11	Reserved	Factory	0~65535	/	*	0~65535	
Group d2 Use of Display Parameters							
d2.00	Temperature of heatsink 1	0.0	0.0 ~ 100.0	°C	*	0.0 ~ 100.0°C	
d2.01	Terminal count value	0	0 ~ 65535	/	*	0~65535	
d2.02	A11 percentage after curvilinear transformation	0.0	0.0 ~ 100.0	%	*	0.0~100.0%	
d2.03	A12 percentage after curvilinear transformation	0.0	0.0 ~ 100.0	%	*	0.0~100.0%	
d2.04	A13 percentage after curvilinear transformation	0.0	0.0 ~ 100.0	%	*	0.0~100.0%	
d2.05	D1 percentage after curvilinear transformation	0.0	0.0 ~ 100.0	%	*	0.0~100.0%	
d2.06	Operation panel $\wedge \vee$ digital adjustment value	0	0 ~ 65535	/	*	0~65535	
d2.07	Terminal UP/DN digital adjustment volume	0	0 ~ 65535	/	*	0~65535	
d2.08	Reserved	Factory	0 ~ 65535	/	*	0~65535	
d2.09	Input status display of X terminal	0000	0~FFFF	/	*	0~FFFF	
d2.10	Reference voltage 1 (percentage)	Factory	0.0~100.0	%	*	0.0~100.0%	
d2.11	Reference voltage 2 (percentage)	Factory	0.0~100.0	%	*	0.0~100.0%	
d2.12	A1 failure source display	Factory	0~5	/	*	1: A11 exceeding limit; 2: A12 exceeding limit; 3: A13 exceeding limit; 4: AV4/A14 exceeding limit; 5: AV5/A15 exceeding limit	
d2.13	Current detection failure source display	Factory	0~6	/	*	2: Phase W abnormal; 4: Phase V abnormal; 6: Phase U abnormal	
d2.14	Frequency corresponding to the current rotation speed of the motor	0.00Hz	0~655.35	Hz	*	0~655.35Hz	
d2.15 to d2.24	Reserved	Factory	0~65535	/	*	0~65535	
Group A0 User-defined Function Code Displayed/hidden Zone Parameters							
A0.00	Password of displayed/hidden zone of user-defined function code	1	0 ~ FFFF	/	o	0 ~ FFFF	
A0.01	Displayed/hidden function 1 of the user-defined function code	FFFF	0 ~ FFFF	/	o	0 ~ FFFF	
A0.02	Displayed/hidden function 2 of the user-defined function code	FFFF	0 ~ FFFF	/	o	0 ~ FFFF	

5.2 User's Parameter Record

Function code	Setting	Function code	Setting	Function code	Setting
d1.00		d1.01		d1.02	
d1.03		d1.04		d1.05	
d1.06		d1.07		d1.08	
d1.09		d1.10		Recorder:	

5.3 User's Connection Diagram

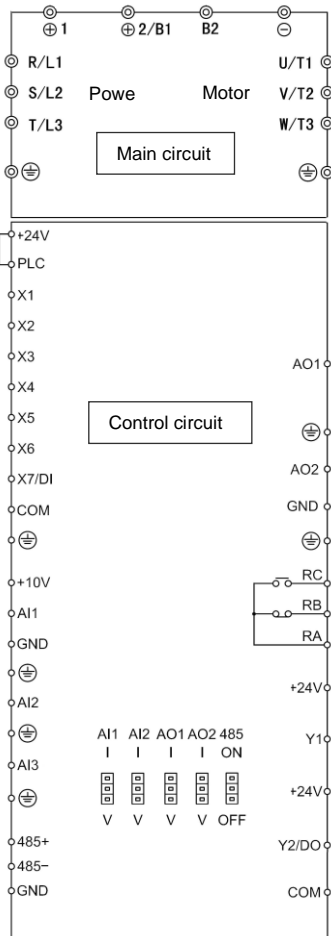

Chapter 6 Parameter Description

6.1 Basic Function Parameter (Group P0)

P0.00	User password	0~FFFF(0)
-------	---------------	-----------

This function is used to prevent the irrelevant personnel from inquiring and changing the parameters, so as to protect the safety of the inverter parameters.

0000: No password protection: All the parameters in Zone P can be inquired and changed (If P0.01=1, the change to parameters is disabled), and no password is set upon inverter delivery.

Set password:

Input four digits as user password, and press **PRG** key for confirmation. Repeat this operation once.

Change password:

Press **PRG** key to enter the password verification status, and 0.0.0.0. is displayed. Input correct password, and it enters parameter editing status. Select P0.00 (parameter P0.00 displayed as 0000). Input new password and press **PRG** key for confirmation. Set the same password for P0.00 twice.

When "P.Set" is displayed, the new password is successfully set.

Cancel password:

Press **PRG** key to enter the password verification status, and 0.0.0.0. is displayed. Input correct user password to enter the parameter editing status, check if P0.00 is 0000. Press **PRG** key for confirmation, and set P0.00=0000 again, and then "P.Clr" is displayed and the password is cancelled.

Note: For the method for activating the password, refer to 4.5 password operation.

P0.01	Function code protection	0~5(0)
-------	--------------------------	--------

This function is used to set the modification authority and initialization level of the parameters.

0: All the parameters are allowed for modification.

1: All the parameters are disallowed for modification.

2: Restore all the parameters in zone P to leave-factory setting.

3: Restore all the parameters in zone P except for the motor parameters (group P9) to leave-factory setting.

4: Restore all the P zone parameters and A zone parameters (user's customized function code display/hide zone) to leave-factory values.

5: Restore all the user parameters except for d group to leave-factory values.

Note: After the parameters are initialized, the password set by the user will be automatically reset.

P0.02	Function code display	0~3(0)
-------	-----------------------	--------

Set this function, and the operation panel will display the function code parameters according to the actual need of the user to improve the work efficiency.

0: Basic menu mode: The operation panel can display all the parameters.

1: Fast menu mode: The operation panel only displays the fast parameters defined by the manufacturer.

When the basic functions of the inverter are used, this menu mode shall be set.

2: Menu mode of non-leave-factory value function code: The operation panel only displays the parameters different from the leave-factory values.

- ◆ When the technical personnel perform onsite maintenance, to quickly view the parameters set by the user and detect the failure, this mode can be used.
- ◆ After the inverter commissioning is completed, to conveniently record and inquire the modified parameters, this mode can be set.

3: Menu mode of last changed 10 function codes: When the inverter has abnormal operation or it is necessary to inquire the commissioning parameters, the last changed 10 parameters can be inquired by setting this menu mode. When the leave-factory parameters are recovered, the record of the last changed 10 function codes will also be cleared.

Note:

- ◆ Both P0.00 and P0.02 are visible in all the menu display modes for the convenience of menu mode switching.
- ◆ Press ESC key and hold for over 5 seconds, it will restore to basic menu mode, and P0.02 is automatically restored to 0.
- ◆ In non-basic menu mode, the >> key cannot be used to switch the function zone code and group number. The current menu mode will be displayed after pressing the >> key for several times.

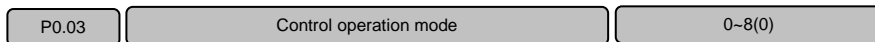

This function is used to set the control operation mode of the inverter. 0 ~ 3 indicates vector control 1, 4 ~ 8 indicates vector control 2.

Vector control 1 without encoder speed feedback:

0: Process open loop control: It is applicable to most applications, including the application of one inverter driving one motor and the application of one inverter driving multiple motors (the motors are in the same work conditions).

1: Analog value feedback process close loop control: It is applicable to applications with general requirement of speed control precision. The feedback analog can represent such parameters as temperature, pressure and humidity. For the reference and feedback setting of the analog feedback process close loop control, refer to P1.02~P1.07 function description. For the setting of the process PID close loop parameters, refer to Group P8 function code description.

AI1 and AI2 terminal input specification: 0~10V or 0~20mA.

AI3 terminal input specification: -10~10V;

X7/DI terminal input specification: 0~ maximum input pulse frequency P5.10.

2: Single-phase pulse feedback process close loop control: It is applicable to applications with higher speed control precision, and pulse encoder shall be installed at the motor end or mechanical equipment axle end. Single-phase pulse feedback channel: X7/DI terminal: The X7/DI terminal function must be set to process close loop control single-phase pulse input (P5.06=47) .

3: Composite control: The composite control of process open loop and analog feedback closed loop is suitable for special applications.

As for the set frequency of the inverter, if it is necessary to made fine tuning on another physical parameter in the system in addition to the open loop setting, closed loop adjustment can be made to this

physical parameter. The adjustment result will be added to the open loop frequency reference of the inverter, so as to ensure the constancy of the physical parameter through speed control. Refer to the description of the open loop and closed loop composite operation relation calculation parameter P1.08.

Vector control 2 without encoder speed feedback:

- 4: Process open loop control: Applicable to high performance applications and features high rotation speed precision, high torque precision and eliminates the need for pulse encoder.
- 5: Analog value feedback process close loop control: Refer to Parameter setting 1 of this function code.
- 6: Single-phase pulse process close loop control: Refer to Parameter setting 2 of this function code.
- 7: Composite control: For the composite control of process open loop and analog feedback closed loop, refer to parameter setting 3 of this function code

Vector control 2 with encoder speed feedback:

- 8: Process open loop control: Pulse encoder is needed, and it can realize rotation speed and torque performance with higher precision than the vector control 2 without encoder speed feedback.

P0.04	Open loop main reference mode	0~4(0)
P0.05	Open loop digital frequency reference	0.00~300.00 Hz (50.00Hz)

This function is applicable to the frequency reference of open loop control mode, such as vector control 1, vector control 2. For the speed reference of process close loop control mode, refer to function code of Group P1.

0: Set frequency reference via P0.05.

Note: If multi-section digital voltage terminals 1 ~ 3 are valid, the frequency is determined by the terminal combination. Refer to P4.15~P4.21. If multi-section frequency terminals 1 ~ 4 are valid, the frequency is determined by the terminal combination. Refer to P4.22~P4.36.

1: Set frequency reference via AI1 port.

2: Set frequency reference via AI2 port.

Input specification of AI1 and AI2 terminals: 0~10V or 0~20mA. The correspondence relation between the analog and the reference frequency is defined by group P6.

Note: When adopting the current input of 0~20mA, refer to the description of P6.01~P6.08.

3: Set frequency reference via AI3 port.

Input specification of AI3 terminal: -10~10V. The correspondence relation between the analog absolute value and the reference frequency is defined by group P6. The operation direction is determined by the sign of the AI3 analog input.

4: Set frequency reference via X7/DI port.

X7/DI terminal input specification: 0~maximum pulse frequency P5.10. The correspondence relation between the pulse signal and the reference frequency is defined by group P6.

Note: When P0.04=4, the X7/DI terminal function must be set to pulse frequency DI input (P5.06=5) .

P0.06	Running command reference mode	0~2(0)
-------	--------------------------------	--------

Three different operating command reference modes can be selected for the inverter.

0: Operation panel mode: Perform the Run, Stop, Forward/reverse operation of the inverter through the RUN, STOP/RST, FWD/REV buttons of the operation panel.

1: Terminal mode: Perform the Run, Stop, Forward/reverse operation of the inverter by defining the multi-functional terminals X1~X7. Refer to the description of P5.00~P5.06 and P5.11.

2: Host computer mode: Perform the Run, Stop, Forward/reverse operation of the inverter through communication. Refer to the appendix A Modbus communication protocol.

P0.07	Running direction command	0~1(0)
-------	---------------------------	--------

This parameter is used to change the rotation direction of the motor under operation panel running command reference mode (P0.06=0).

0: Forward; 1: Reverse

Note: This function code is invalid under terminal running command reference mode, and the running direction is controlled by terminal command.

P0.08	Acceleration time 0	0.1~3600.0 s(6.0s or 20.0s)
P0.09	Deceleration time 0	0.1~3600.0 s(6.0s or 20.0s)
P0.10	S curve time	0.0~3600.0 s(0.0s)

This function can set the speed and stability in the duration from acceleration to constant speed after the startup of the inverter, or from constant deceleration to stop.

Acceleration time 0: The time that the inverter accelerate from 0 frequency to maximum frequency.

Deceleration time 0: The time that the inverter accelerate from maximum frequency to 0 frequency.

S curve time: The time for adding curve segment to improve the smoothness of the start and ending section during the acceleration and deceleration, P0.10. S curve time is applicable to the belt conveyer that carries fragile materials or applications requiring smooth speed adjustment.

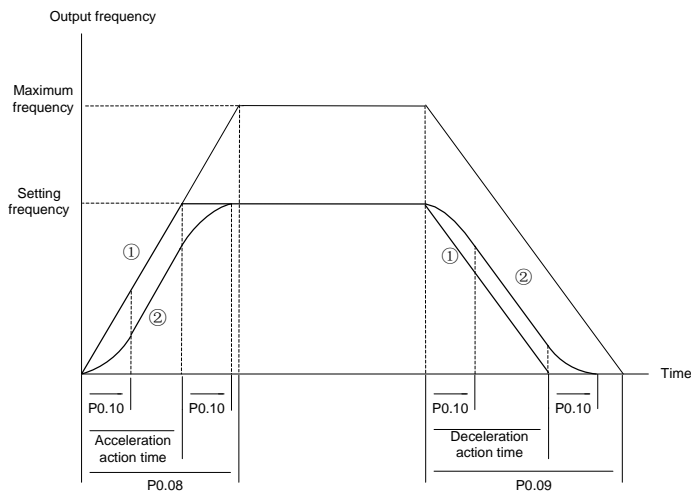

Fig.6-1 Acceleration/deceleration time and S curve

When P0.10 is set as 0, it indicates that there is no S curve time, and the acceleration and deceleration is in linear mode.

Acceleration time = $P0.08 \times \text{set frequency} / P0.11$; deceleration time = $P0.09 \times \text{set frequency} / P0.11$.

When P0.10 is set as a non-zero value, it indicates that there is S curve time, and the acceleration and deceleration adopts S curve mode.

S curve acceleration/deceleration time = acceleration/deceleration time + S curve time.

As shown in Fig.6-1, curve 1 is the curve representing the acceleration/deceleration in linear mode, curve 2 is the curve representing the acceleration/deceleration in S curve mode.

Curves 1 and 2 corresponding to the same setting frequency. The actual acceleration/deceleration time of curve 2 is longer than that of curve 1 by the time set by P0.10.

Note:

- ◆ The S curve acceleration/deceleration setting is also available for acceleration times 1, 2 and 3 (P4.09~P4.14), with the principle same as above.
- ◆ It is appropriate when the ratio between the S curve time and the acceleration/deceleration time is 1/5.

P0.11	Maximum output frequency	0.01~300.00 Hz(50.00Hz)
P0.12	Maximum output voltage	1~480 V(380V)
P0.13	Frequency upper limit	0.00~300.00 Hz(50.00Hz)
P0.14	Frequency lower limit	0.00~300.00 Hz(0.00Hz)
P0.15	Basic operating frequency	0.00~300.00 Hz(50.00Hz)

The maximum output frequency f_{max} is the allowable maximum output frequency of the inverter.

The maximum output voltage V_{max} is the output voltage when the inverter is in basic operating frequency.

When standard AC motor is used, it corresponds to the motor rated voltage. Refer to motor nameplate.

The frequency upper limit f_H and frequency lower limit f_L are the maximum and minimum operating frequency of the motor set according to the production process requirement by the user during the use.

The basic operating frequency f_b is the minimum frequency corresponding to the maximum output voltage of the inverter. When standard AC motor is used, it corresponds to the rated frequency of the motor. Refer to the motor nameplate.

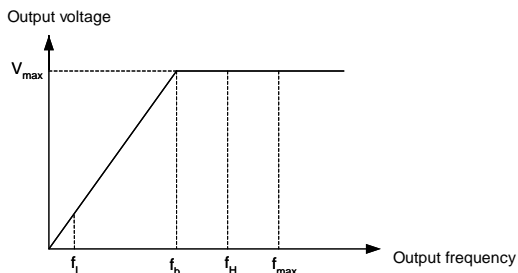

Fig.6-2 Characteristic parameter definition

P0.16	Torque boost	0.0~30.0 %(0.0%)
-------	--------------	------------------

Effect of the torque boost function: Upon the vector control 1, when the inverter operation at low-frequency, increase the output voltage, and offset the stator voltage drop to product enough torque, so as to ensure the normal operation of the motor.

Note:

- ◆ The torque boost amplitude should be set according to the load situation. Excessive boost will cause large current impact during the startup process.
- ◆ When P0.16 is set as 0.0, and P4.00 is set as 0 (linear V/F curve), the automatic torque boost mode is enable; when P4.00 is set as a non-zero value, the automatic torque increase mode is disabled.

6.2 Main and Auxiliary Reference Parameter (Group P1)

P1.00	Open loop auxiliary reference mode	0~4(0)
P1.01	Open loop reference main and auxiliary relation calculation	0~5(0)

In process open loop control mode (P0.03=0 or P0.03=4), the main reference value f_m will be added with an auxiliary reference value f_a , and it results in process open loop combination frequency reference f_{com} .

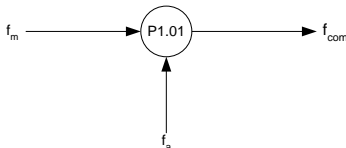

Fig.6-3 Open loop main and auxiliary reference combination

The process open loop auxiliary reference mode P1.00 is selected as follows:

0: none; 1: AI1; 2: AI2; 3: AI3; 4: DI

Such calculations as “add”, “subtract”, “bias”, “max” and “min” are available for main reference value f_m and auxiliary reference value f_a .

Through the setting of parameters in group P6, the frequency change range of the auxiliary reference can be reduced to realize the fine tuning function.

The process open loop reference main and auxiliary relation calculation parameter P1.01 is defined as follows:

0: Main reference + auxiliary reference: The auxiliary frequency reference value is superimposed on the main reference, the function is “add”.

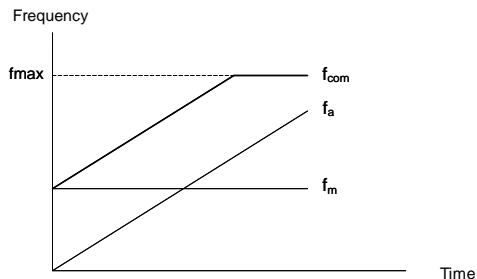

Fig.6-4 Process open loop main and auxiliary reference calculation 0

Open loop combination reference $f_{com} = \text{main reference } f_m + \text{auxiliary reference } f_a$

1: Main reference – auxiliary reference: The auxiliary frequency reference value is superimposed on the main reference, the function is “subtract”.

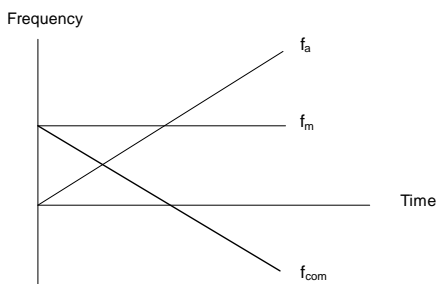

Fig.6-5 Process open loop main and auxiliary reference calculation 1

Open loop combination reference $f_{com} = \text{main reference } f_m - \text{auxiliary reference } f_a$

2: Auxiliary reference-50%: The auxiliary reference value subtracts the bias equal to 50% of the auxiliary reference full range value. The main reference value is invalid at this time.

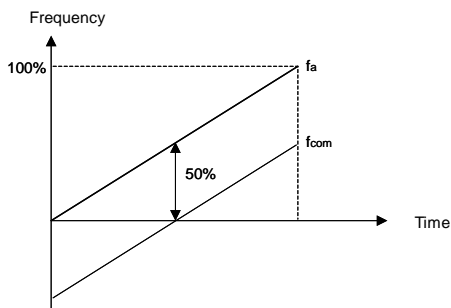

Fig.6-6 Process open loop main and auxiliary reference calculation 2

Open loop combination reference $f_{com} = \text{auxiliary reference } f_a - 50\% \text{ bias}$

3: Main reference + auxiliary reference-50%: The auxiliary reference value subtracts the bias equal to 50% of the auxiliary reference full range value and then superimposes on the main reference.

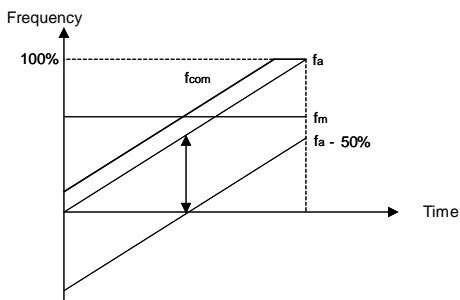

Fig.6-7 Process open loop main and auxiliary reference calculation 3

Open loop combination reference $f_{com} = \text{main reference } f_m + \text{auxiliary reference } f_a - 50\% \text{ bias}$

4: Max: Get the maximum value of the main reference f_m and the auxiliary reference f_a .

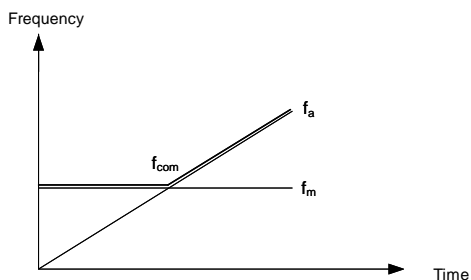

Fig.6-8 Process open loop main and auxiliary reference calculation 4

Open loop combination reference $f_{com} = \text{Max} \{ \text{main reference } f_m, \text{auxiliary reference } f_a \}$

5: Min: Get the minimum value of the main reference f_m and the auxiliary reference f_a .

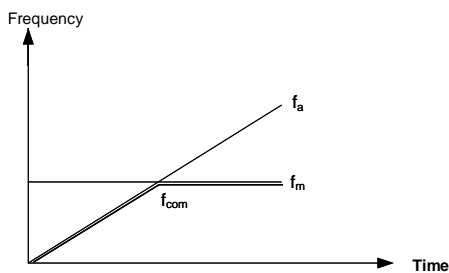

Fig.6-9 Process open loop main and auxiliary reference calculation 5

Open loop combination reference $f_{com} = \text{Min} \{ \text{main reference } f_m, \text{auxiliary reference } f_a \}$

Note: When the corresponding frequency of the combination value f_{com} exceeds the upper or lower limit of the frequency, the output frequency will be restricted to the upper or lower limit.

P1.02	Analog feedback close loop control main reference mode	0~4(0)
P1.03	Analog feedback close loop control auxiliary reference mode	0~4(0)
P1.04	Analog feedback close loop control reference main and auxiliary calculation	0~5(0)

In the analog feedback close loop system, if there are main reference and auxiliary reference, the main reference value can be digital voltage, analog and pulse, the auxiliary reference value can be analog and pulse.

The analog feedback close loop control main reference mode P1.02 may be selected as follows:

0: Digital voltage reference (P8.00) ; 1: AI1; 2: AI2; 3: AI3; 4: DI

Digital voltage definition: 0~10V is indicated in digits in parameter P8.00.

The analog feedback close loop control auxiliary reference mode P1.03 may be selected as follows:

0: None; 1: AI1; 2: AI2; 3: AI3; 4: DI

The analog feedback close loop control main reference and auxiliary reference calculation P1.03 can be selected as follows:

0: Main + auxiliary; 1: Main - auxiliary; 2: Auxiliary -50%; 3: Main+ auxiliary-50%; 4: Max; 5: Min

The main reference and auxiliary reference calculation function for close loop reference is the same as the main reference and auxiliary reference calculation function for open loop reference. For details, refer to the description of P1.01.

Note: Under the analog feedback close loop control mode, the analog main reference, analog auxiliary reference, analog main feedback and analog auxiliary feedback cannot be set at the same channel.

P1.05	Analog feedback close loop control main feedback mode	1~4(1)
P1.06	Analog feedback close loop control auxiliary feedback mode	0~4(0)
P1.07	Analog feedback close loop control feedback main and auxiliary calculation	0~5(0)

In the analog feedback close loop system, the main feedback and auxiliary feedback can be analog or pulse.

The main feedback and auxiliary feedback calculation function for process close loop feedback is the same as the main reference and auxiliary reference calculation function for process close loop reference. For details, refer to the description of P1.01.

The analog feedback close loop control main feedback mode P1.05 may be selected as follows:

1: AI1; 2: AI2; 3: AI3; 4: DI

The analog feedback close loop control auxiliary feedback mode P1.06 may be selected as follows:

0: none; 1: AI1; 2: AI2; 3: AI3; 4: DI

The analog feedback close loop control main feedback and auxiliary feedback calculation P1.07 may be selected as follows:

0: Main + auxiliary; 1: Main - auxiliary; 2: Auxiliary -50%; 3: Main+ auxiliary-50%; 4: Max; 5: Min.

Note:

- ◆ Under the analog feedback close loop control mode, the analog main reference, analog auxiliary reference, analog main feedback and analog auxiliary feedback cannot be set at the same channel.
- ◆ When the process close loop analog feedback mode is DI, the pulse will be translated into analog (0~10V) as feedback:
Analog = pulse/maximum pulse input frequency P5.10×10V.

P1.08	Process open loop and close loop composite operation relation calculation	0~1 (0)
-------	---	---------

This function definition is similar to that of P1.01. The process open loop composite reference f_{com} in this function definition can be treated as main reference, the frequency output of closed loop PID adjustment f_{PID} can be treated as auxiliary reference, and f_{FIN} can be treated as composite reference.

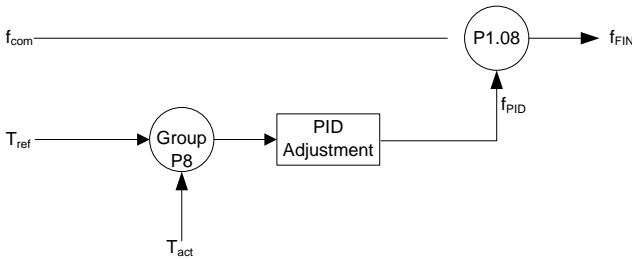

Fig.6-10 Open loop and closed loop composite operation reference

0: Add the process closed loop adjustment result f_{PID} to the process open loop reference f_{com}

1: Subtract the process closed loop adjustment result f_{PID} from the process open loop reference f_{com}

Note: In the case of analog feedback closed loop, refer to description of P1.02 to P1.04 for the reference mode T_{ref} , refer to the description of P1.05 to P1.07 for the feedback mode T_{act} .

6.3 Key and Display Parameters (Group P2)

P2.00	Key-lock function selection	0~3(0)
-------	-----------------------------	--------

It is to realize the locking function of the keys on the operation panel, so as to avoid mis-operation.

0: The keys on the operation panel are not locked, and all the keys are usable.

1: The keys on the operation panel are locked, and all the keys are unusable.

2: All the keys except for the multi-functional key are unusable.

3: All the keys except for the RUN AND STOP/RST keys are unusable.

Note: For the effective methods of key locking, refer to 4.6 description on key locking and unlocking.

P2.01	Multi-functional key definition	0~8(1)
-------	---------------------------------	--------

To facilitate the operation, the frequent operation can be set on the multi-functional key of the operation panel.

0: No function.

1: Jog function: For the jog frequency and jog acceleration/deceleration time, refer to P3.11~P3.13.

2: Emergency shutdown 1: Applicable to the situation that may cause human danger. The motor will be stopped with the shortest deceleration time.

3: Emergency shutdown 2: Applicable to the situation that may cause electric equipment damage. The motor will be stopped freely.

4: Realize the circular switching of the operating command reference modes (operation panel reference →terminal reference→host computer reference). The MON status LED on the operation panel will indicate the corresponding status. It is effective only when the PRG key is pressed within 5 seconds, otherwise, the switching will be invalid, and the MON LED will restore to the former indication state.

5: Realize the circular switching of the display modes of fast function codes and all the function codes.

6: Realize the circular switching of the display modes of function codes different from leave-factory values and all the function codes.

7: Realize the circular switching of the display modes of last changed 10 function codes and all the function codes.

8: Realize the circular switching of different function code display modes (basic menu mode → fast menu mode → menu mode of non-leave-factory value function code→Menu mode of last changed 0 function codes, refer to description of P0.02 for the menu modes.

P2.02

Display parameter selection at running

0~FFFF(1CB0)

Up to 4 parameters can be set and display at running status, and viewed circularly by pressing >>>key.

Display of operation panel		
Unit place:	0: Reference frequency (Hz) ;	1: Bus voltage (V) ;
	2: AI1 (V) ;	3: AI2 (V) ;
	4: AI3 (V) ;	5: DI (%) ;
	6: External counts	7: Motor rotation speed (rpm);
	8: Close loop reference (%);	9: Close loop feedback (%);
	A: Reference torque (%);	B: Operating frequency (Hz);
	C: Output current (A);	D: Output torque (%);
	E: Output power (kW);	F: Output voltage (V)
Tens place	Same as above	
Hundreds place	Same as above	
Thousands place	Same as above	

P2.04	Running proportion display benchmark	0~F(0)
P2.05	Running proportion display coefficient	0.0~1000.0%(0.0%)

If the parameter to be displayed has proportion relation with a physical value in the operation display parameter defined by P2.02, P2.04 can be used to designate the physical value as the display benchmark, and P2.05 can be used to set the coefficient of the display benchmark.

When the proportion display parameter is set (i.e. P2.04), the physical value will be automatically added into the operation display parameter group and can be viewed by pressing >>key. At this time, there are 5 display parameters. The LEDs for the newly added parameter are LED A and LED V, both of which shall be on.

P2.03	Display parameter selection at stopping	0~FFFF(3210)
-------	---	--------------

Up to 4 parameters can be set and display at stopping status, and viewed circularly by pressing >>key.

Display of operation panel		
Unit place:	0: Reference frequency (Hz) ;	1: Bus voltage (V) ;
	2: AI1 (V) ;	3: AI2 (V) ;
	4: AI3 (V) ;	5: DI (%) ;
	6: External counts	7: Motor rotation speed (rpm);
	8: Close loop reference (%);	9: Close loop feedback (%);
	A: Reference torque (%);	B: Reserved;
	C: Reserved;	D: Reserved;
	E: Reserved;	F: Reserved
Tens place	Same as above	
Hundreds place	Same as above	
Thousands place	Same as above	

P2.06	Stop proportion display benchmark	0~F(0)
P2.07	Stop proportion display coefficient	0.0~1000.0 %(0.0%)

If the parameter to be displayed has proportion relation with a physical value in the stopping display parameter defined by P2.03, P2.06 can be used to designate the physical value as the display benchmark, and P2.07 can be used to set the coefficient of the display benchmark.

When the proportion display parameter is set (i.e. P2.06), the physical value will be automatically added into the stop display parameter group and can be viewed by pressing >>key. At this time, there are 5 display parameters. The LEDs for the newly added parameter are LED A and LED V, both of which shall be on.

6.4 Startup/stop Parameter (Group P3)

P3.00	Startup mode	0~2(0)
-------	--------------	--------

Different startup modes can be adopted for different applications.

0: The inverter begins to run from the startup frequency P3.03 and accelerates to the setting frequency after the startup frequency retention time P3.04. If the motor is still rotating upon the startup of the inverter, the motor will be automatically decelerated to low speed before the acceleration.

1: DC current is injected first to perform DC magnetizing and DC braking on the motor. The volume and time for the DC injection are set by P3.01 and P3.02. After the DC injection time expires, the inverter begins to run from the startup frequency P3.03 and accelerates to the setting frequency after the startup frequency retention time P3.04.

2: Flying startup.

The inverter will automatically identify the speed of the motor and directly start from the identified frequency. The current and voltage are smooth without any impact during the startup.

Note: During the DC current supply, the operation panel displays “-dc-”.

P3.01	DC injection current	0.0~120.0 %(0.0%)
P3.02	DC injection time	0.00~30.00 s (0.00s)

P3.01 sets the volume of the DC injection current, which is indicated in a percentage of the rated current of the inverter. Upon variable torque load: 0.0~90.0%.

P3.02 sets the action time of the DC injection.

P3.03	Startup frequency	0.00~60.00Hz(0.00or 0.50Hz)
P3.04	Startup frequency retention time	0.0~3600.0 s (0.0s)

The inverter begins to run from the startup frequency P3.03 and accelerates according to acceleration time after the startup frequency retention time P3.04.

Note: For the heavy-load startup applications, it will facilitate the startup if the startup frequency and retention time are properly set. For vector control 2 with encoder speed feedback, the leave-factory values of startup frequency is 0.00Hz. and other control mode is 0.50Hz.

P3.05	Stop mode	0~2(0)
-------	-----------	--------

Different stop modes can be adopted for different applications.

0: Decelerate to stop according to the deceleration time.

1: The inverter locks the output and the motor coast to stop.

2: Decelerate to stop according to the deceleration time. When the frequency is lower than the DC braking initial frequency P3.06, inject the DC braking current P3.07, and the DC braking time is determined by P3.08.

Note: During the DC braking, the operation panel displays “-dc-”.

P3.06	DC braking initial frequency	0.00~300.00 Hz(0.00Hz)
P3.07	DC braking current	0.0~120.0 %(0.0%)
P3.08	DC braking time	0.00~30.00 s (0.00s)

P3.06 sets the initial frequency at the beginning of DC braking current injection during the shutdown

P3.07 sets the DC braking current value. This value is presented as the percentage of the rated current of the inverter. It ranges from 0.0 ~ 90.0% upon variable torque load.

P3.08 sets the action time of the DC braking current.

P3.09	Anti-reverse selection	0~1(1)
P3.10	Forward/reverse dead zone time	0.0~3600.0 s(0.0s)

For some production equipment, reverse operation may cause equipment damage. This function can be used to prevent reverse operation. P3.09 is set to forbid reverse operation by default upon delivery.

When the motor rotation direction is opposite to the required direction of the equipment, the wire connection of any two terminals at the output side the inverter can be interchanged so that the forward rotation direction of the equipment is consistent with the forward rotation direction defined by the inverter.

Set P3.10 to realize the waiting time for the zero-crossing of rotation speed when the inverter switches from forward rotation to reverse rotation (or from reverse rotation to forward rotation).

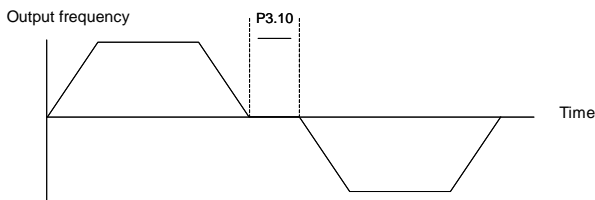

Fig.6-11 Forward/reverse dead zone time

P3.11	Jog frequency	0.10~300.00 Hz (5.00Hz)
P3.12	Jog acceleration time	0.1~60.0 s(6.0s)
P3.13	Jog deceleration time	0.1~60.0 s(6.0s)

P3.11 is the frequency set for jog operation.

Jog acceleration time P3.12: The time from zero to maximum frequency.

Jog deceleration time P3.13: The time from maximum frequency to zero.

When the inverter is in standby status, it can adopt jog operation. The jog operation command may come from the operation panel, multi-functional terminal or host computer.

Note: The jogging function is invalid under torque control.

6.5 Multi-section Parameter (Group P4)

P4.00	V/F curve reference	0-6(0)
P4.01	V/F frequency value F0	0.00~300.00 Hz(0.00Hz)
P4.02	V/F voltage value V0	0.0~100.0 %(0.0%)
P4.03	V/F frequency value F1	0.00~300.00 Hz(0.00Hz)
P4.04	V/F voltage value V1	0.0~100.0 %(0.0%)
P4.05	V/F frequency value F2	0.00~300.00 Hz(0.00Hz)
P4.06	V/F voltage value V2	0.0~100.0 %(0.0%)
P4.07	V/F frequency value F3	0.00~300.00 Hz(0.00Hz)
P4.08	V/F voltage value V3	0.0~100.0 %(0.0%)

It is to determine the different V/F curves under vector control 1 mode.

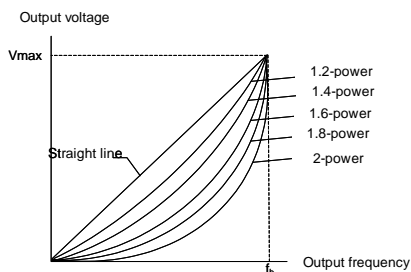

Fig. 6-12 V/F curve

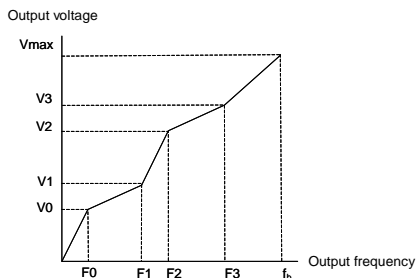

Fig. 6-13 Multi-section V/F curve

P4.00=0: Applicable to the constant torque load situation, refer to the straight line in Fig.6-12.

P4.00=1: Self-defined curve of the user, applicable to sectional constant torque load, refer to Fig.6-13.

In Fig.6-13: $F_0 < F_1 < F_2 < F_3 < f_b$ f_b is the motor basic frequency P0.15

$V_0 \leq V_1 \leq V_2 \leq V_3 \leq 100\%$ V_0, V_1, V_2, V_3 are indicated in the percentage of the maximum output frequency P0.12.

P4.00=2~6: Applicable to the variable torque loads such as fan and pump. When P4.00 is set to 2~6, it corresponds to 1.2-power, 1.4-power, 1.6-power, 1.8-power and second power, as shown in Fig.6-12.

The second power curve is for water supply, and the 1.2-power to 1.8-power curves are for the liquid loads of other media. Proper curve can be selected according to the actual situation.

P4.09	Acceleration time 1	0.1~3600.0 s(20.0s)
P4.10	Deceleration time 1	0.1~3600.0 s(20.0s)
P4.11	Acceleration time 2	0.1~3600.0 s(20.0s)
P4.12	Deceleration time 2	0.1~3600.0 s(20.0s)
P4.13	Acceleration time 3	0.1~3600.0 s(20.0s)
P4.14	Deceleration time 3	0.1~3600.0 s(20.0s)

In addition to the above acceleration time 0 (P0.08) and deceleration time 0 (P0.09) , three groups of acceleration/deceleration time (acceleration/deceleration time 1, acceleration/deceleration time 2, acceleration/deceleration time 3) can be defined. Different acceleration/deceleration time can be selected in different terminal status by defining the multi-functional terminal X (acceleration/deceleration time selection function: 13–14). The meaning of the three groups of acceleration/deceleration time is the same as P0.08 and P0.09.

P4.15	Multi-section digital voltage reference 1	0.00~10.00 V(1.00V)
P4.16	Multi-section digital voltage reference2	0.00~10.00 V(2.00V)
P4.17	Multi-section digital voltage reference3	0.00~10.00 V(3.00V)
P4.18	Multi-section digital voltage reference4	0.00~10.00 V(5.00V)
P4.19	Multi-section digital voltage reference5	0.00~10.00 V(6.00V)
P4.20	Multi-section digital voltage reference6	0.00~10.00 V(8.00V)
P4.21	Multi-section digital voltage reference7	0.00~10.00 V(10.00V)

It can be used as the process open loop frequency reference or analog feedback close loop digital reference. Different digital voltage reference is selected in different terminal status by defining the multi-functional terminal X (multi-section analog input terminals 1~3). ON means that the terminal is enabled, OFF means that the terminal is disabled.

Multi-stage digital voltage input terminal 3	Multi-stage digital voltage input terminal 2	Multi-stage digital voltage input terminal 1	Setting frequency	
			Process open loop control	Process PID close loop control
OFF	OFF	OFF	Open loop frequency P0.05	Close loop digital voltage reference
OFF	OFF	ON	Multi-section digital voltage reference 1	Multi-section digital voltage reference 1
OFF	ON	OFF	Multi-section digital voltage reference 2	Multi-section digital voltage reference 2
OFF	ON	ON	Multi-section digital voltage reference 3	Multi-section digital voltage reference 3
ON	OFF	OFF	Multi-section digital voltage reference 4	Multi-section digital voltage reference 4
ON	OFF	ON	Multi-section digital voltage reference 5	Multi-section digital voltage reference 5
ON	ON	OFF	Multi-section digital voltage reference 6	Multi-section digital voltage reference 6
ON	ON	ON	Multi-section digital voltage reference 7	Multi-section digital voltage reference 7

Note: Upon process open loop operation, if the input terminal function sets the multi-section digital voltage and multi-section frequency simultaneously, the multi-section frequency will have priority. Upon

analog feedback operation, the multi-section digital voltage reference is in priority to other reference modes.

P4.22	Multi-section frequency 1	0.00~300.00 Hz(5.00Hz)
P4.23	Multi-section frequency 2	0.00~300.00 Hz(8.00Hz)
P4.24	Multi-section frequency 3	0.00~300.00 Hz(10.00Hz)
P4.25	Multi-section frequency 4	0.00~300.00 Hz(15.00Hz)
P4.26	Multi-section frequency 5	0.00~300.00 Hz(18.00Hz)
P4.27	Multi-section frequency 6	0.00~300.00 Hz(20.00Hz)
P4.28	Multi-section frequency 7	0.00~300.00 Hz(25.00Hz)
P4.29	Multi-section frequency 8	0.00~300.00 Hz(28.00Hz)
P4.30	Multi-section frequency 9	0.00~300.00 Hz(30.00Hz)
P4.31	Multi-section frequency 10	0.00~300.00 Hz(35.00Hz)
P4.32	Multi-section frequency 11	0.00~300.00 Hz(38.00Hz)
P4.33	Multi-section frequency 12	0.00~300.00 Hz(40.00Hz)
P4.34	Multi-section frequency 13	0.00~300.00 Hz(45.00Hz)
P4.35	Multi-section frequency 14	0.00~300.00 Hz(48.00Hz)
P4.36	Multi-section frequency 15	0.00~300.00 Hz(50.00Hz)

It can be used as process open loop frequency reference. Different multi-section frequency reference can be selected in different terminal status by defining the multi-functional terminal X (multi-section frequency terminals 1~4). ON means that the terminal is enabled, OFF means that the terminal is disabled.

Note: Upon open loop operation, if the input terminal function sets the multi-section digital voltage and multi-section frequency simultaneously, the multi-section frequency has the highest priority.

Multi-section frequency terminal 1	Multi-section frequency terminal 3	Multi-section frequency terminal 2	Multi-section frequency terminal 1	Setting frequency
OFF	OFF	OFF	OFF	Open loop frequency P0.05
OFF	OFF	OFF	ON	Multi-section frequency 1
OFF	OFF	ON	OFF	Multi-section frequency 2
OFF	OFF	ON	ON	Multi-section frequency 3
OFF	ON	OFF	OFF	Multi-section frequency 4
OFF	ON	OFF	ON	Multi-section frequency 5
OFF	ON	ON	OFF	Multi-section frequency 6
OFF	ON	ON	ON	Multi-section frequency 7
ON	OFF	OFF	OFF	Multi-section frequency 8
ON	OFF	OFF	ON	Multi-section frequency 9
ON	OFF	ON	OFF	Multi-section frequency 10
ON	OFF	ON	ON	Multi-section frequency 11
ON	ON	OFF	OFF	Multi-section frequency 12
ON	ON	OFF	ON	Multi-section frequency 13
ON	ON	ON	OFF	Multi-section frequency 14
ON	ON	ON	ON	Multi-section frequency 15

6.6 Multi-functional Input Parameter (Group P5)

P5.00	X1 terminal input function selection	0~99(99)
P5.01	X2 terminal input function selection	0~99(99)
P5.02	X3 terminal input function selection	0~99(99)
P5.03	X4 terminal input function selection	0~99(99)
P5.04	X5 terminal input function selection	0~99(99)
P5.05	X6 terminal input function selection	0~99(99)
P5.06	X7 terminal input function selection	0~99(99)

Multi-functional input terminal definition table:

SN	Function definition	SN	Function definition
0	Jog forward	27	Shutdown via terminal with DC braking 2
1	Jog reverse	28	Counter trigger input
2	Forward (FWD)	29	Counter trigger reset
3	Reverse (REV)	30-46	Reserved
4	Three-wire operation control	47	PG feedback closed loop control single phase pulse input
5	Pulse frequency DI input (only available for X7/DI terminal)	48	Command switching to operation panel
6	Multi-section digital voltage terminal 1	49	Command switching to terminal
7	Multi-section digital voltage terminal 2	50	Command switching to host computer
8	Multi-section digital voltage terminal 3	51	Main frequency source close loop and open loop switching input
9	Multi-section frequency terminal 1	52	Main frequency source switching to digital
10	Multi-section frequency terminal 2	53	Reserved
11	Multi-section frequency terminal 3	54	Main frequency source switching to AI1
12	Multi-section frequency terminal 4	55	Main frequency source switching to AI2
13	Acceleration/deceleration terminal 1	56	Main frequency source switching to AI3
14	Acceleration/deceleration terminal 2	57	Main frequency source switching to DI
15	Digital regulating frequency reset	58	Auxiliary frequency source switching to disabled
16	Frequency increase instruction	59	Reserved
17	Frequency decrease instruction	60	Auxiliary frequency source switching to AI1
18	Acceleration and deceleration disable instruction	61	Auxiliary frequency source switching to AI2
19	External failure input	62	Auxiliary frequency source switching to AI3
20	Terminal failure reset input	63	Auxiliary frequency source switching to DI
21	External interrupt contact input	64	Speed control/torque control switching
22	Inverter running disabled	65	Speed limiting forced to be Pd.06 and Pd.07
23	Shutdown via terminal	66	Zero servo enable terminal
24	Free shutdown via terminal	67	Closed loop output forced to be 0
25	Shutdown via terminal with DC braking 1	68	PID positive or negative function
26	Emergency shutdown 1 (fastest shutdown)	69-98	Reserved

Relevant term explanation:

Terminal Xi: Refers to any of terminal X1, X2, X3, X4, X5, X6 or X7, also called terminal X.

Terminal Yi: Refers to terminal Y1, Y2 or relay also called terminal Y.

Terminal function enabled: Means that terminal Xi has set the function under description. And P7.25 adopts the leave-factory value, the terminal is closed; when the P7.25 adopts the non-leave-factory value, the terminal is open.

Terminal function disabled: Means that terminal Xi has not set the function under description; or it has set the function, but when P7.25 adopts the leave-factory value, the terminal is open; or when the P7.25 adopts the non-leave-factory value, the terminal is closed.

The leave-factory setting of terminal Xi (i=1~7) is no function (function code set as 99).

0: Terminal jog forward input

1: Terminal jog reverse input

2: Terminal forward run input (FWD)

3: Terminal reverse run input (REV)

The functions of above items 0 to 3 are only enabled in the terminal running command reference mode (P0.06=1). Interlocking of running command and jog command means that the jog command will not be executed in the running status and the running command will not be executed in the jog status.

4: Three-line running control

It is only enabled in the terminal running command reference mode ((P0.06=1). Refer to P5.11 for the instructions about its application.

5: Pulse frequency DI input (only available for X7/DI terminal)

When the pulse frequency DI input acts as the reference (e.g. P0.04=4 or P1.02=4), this function must be selected for the X7/DI terminal.

6: Multi-section digital voltage terminal 1

7: Multi-section digital voltage terminal 2

8: Multi-section digital voltage terminal 3

Refer to P4.15 ~ P4.21 for the instructions about its application.

9: Multi-section frequency terminal 1

10: Multi-section frequency terminal 2

11: Multi-section frequency terminal 3

12: Multi-section frequency terminal 4

Refer to P4.22 ~ P4.36 for the instructions about its application.

13: Acceleration/deceleration time terminal 1

14: Acceleration/deceleration time terminal 2

Refer to the table below for the instructions about its application.

Acceleration/deceleration terminal 2	Acceleration/deceleration terminal 1	Acceleration/deceleration time selection
OFF	OFF	Acceleration/deceleration time 0 (P0.08 and P0.09)
OFF	ON	Acceleration/deceleration time 1 (P4.09 and P4.10)
ON	OFF	Acceleration/deceleration time 2 (P4.11 and P4.12)
ON	ON	Acceleration/deceleration time 3 (P4.13 and P4.14)

15: Digital regulating frequency reset

It is used to reset the change values of the setup frequency regulated by the operation panel \wedge/\vee and terminal UP/DN. When this terminal is enabled, the operation panel \wedge/\vee and terminal UP/DN are disabled.

16: Frequency increase command

17: Frequency decrease command

The two terminals are used to modify the setup frequency with UP/DN key.

18: Acceleration/deceleration disable command

If this terminal is enabled, the running frequency will remain unchanged unless stop command is executed.

19: External failure input

When this terminal is enabled, inverter will stop running and display "E.oUt" failure.

20: Terminal failure reset input

This terminal is used to implement failure reset, which can also be done with the STOP/RST key on the operation panel and the host computer command.

21: External interrupt contact input

It is used to interrupt the inverter for a short while. At this time, the inverter output frequency will be zero but the inverter is still in the running status and the RUN indicator is ON. The inverter will continue running after cancel interrupt signal.

22: Inverter running disabled

Once this terminal is enabled, the inverter will coast to stop immediately. Once this terminal is disabled, the inverter will start normally.

23: Shutdown via terminal

When the inverter is in the running status, the inverter will stop running once this terminal is enabled.

24: Coast to stop via terminal

When the inverter is in the running status, the inverter will coast to stop immediately once this terminal is enabled.

25: DC injection braking stop 1 via terminal

When the inverter is in the running status, this terminal can be used to stop the inverter. When the running frequency is lower than the DC braking frequency (P3.06), the inverter will start DC braking. The braking current is set by P3.07, and the braking time is the longer one between the function retention time of this terminal and the DC braking time(P3.08).

26: Emergency shutdown 1 (fastest stop)

When this terminal is enabled, the inverter will stop in the fastest way. The inverter will automatically determine the deceleration time according to the load torque and stop as fast as possible.

27: DC injection braking stop 2 via terminal

Once the stop command is executed on the inverter, when the running frequency is lower than the DC braking frequency (P3.06), the inverter will start DC braking. The braking current is set by P3.07, and the braking time is the longer one between the function retention time of this terminal and the DC braking time at stop (P3.08).

28: Counter trigger input

It can input pulses with frequency of below 200Hz, such as work counting and other slow-speed pulse signals. For details, refer to P5.12 and P5.13.

29: Counter trigger reset

It is used to reset the counting value of the counter trigger input X terminal.

30 to 46: Reserved

47: Single-phase pulse input of single-phase pulse feedback process close loop control (only available for X7/DI terminal).

When the pulse frequency DI input acts as feedback (P0.03=2 or 6), it must set the X7/DI terminal function to single-phase pulse feedback process close loop control single-phase pulse input (P5.06=47). Refer to P8.01 and P0.03 for description of single-phase pulse input feedback close loop.

48: Command switching to operation panel

49: Command switching to terminal

50: Command switching to host computer

The above three functions are set to facilitate the switching of running command reference mode. When the terminal is switching from disabled status to enabled status, The edge trigger is valid.

51: Main frequency source close loop and open loop switching input

It is the process open loop operation and process close loop operation switching terminal. When this terminal is enabled, it means process close loop operation and when the terminal is disable, it means process open loop operation.

52: Main frequency source switching to digital voltage reference

54: Main frequency source switching to AI1

55: Main frequency source switching to AI2

56: Main frequency source switching to AI3

57: Main frequency source switching to DI

The above five functions are set to facilitate the switching of main frequency source. When the terminal is switching from disabled status to enabled status, The edge trigger is valid. When this terminal is enabled, it will switch from the current main frequency source mode to the main frequency source mode corresponding to this terminal function.

58: Auxiliary frequency source switching to disabled

59: Reserved

60: Auxiliary frequency source switching to AI1

61: Auxiliary frequency source switching to AI2

62: Auxiliary frequency source switching to AI3

63: Auxiliary frequency source switching to DI

The above five functions are set to facilitate the switching of auxiliary frequency source. When the terminal is switching from disabled status to enabled status, the edge trigger is valid. When this terminal is enabled, it will switch from the current auxiliary frequency source mode to the auxiliary frequency source mode corresponding to this terminal function.

64: Speed control/torque control switching

This function shall be used together with the speed/torque control Pd.00 function code. Under vector control 2, it can be switched between speed control mode and torque control mode through terminal. If Pd.00 is set as 0 and the terminal function is invalid, it is under speed control. If the terminal function is valid, it switches to torque control. If Pd.00 is set as 1 and the terminal function is invalid, it is under torque control. If the terminal function is valid, it switches to speed control.

Pd.00 \ Terminal	Terminal	Terminal function invalid	Terminal function valid
0	0	Speed control	Torque control
1	1	Torque control	Speed control

65 Speed limiting forced to be Pd.06 and Pd.07

Under torque control, when the terminal function is valid, the speed limiting is Pd.06 and Pd.07. When

the terminal function is invalid, the speed limiting is determined by the corresponding analog channel. Refer to the description of the relevant analog channel of P6.21.

66 Zero servo enable terminal

When this function is valid, the inverter enters zero servo status. For the zero servo functions, refer to the description of the relevant zero servo functions of Pd.25 to Pd.27.

67: Closed loop output forced to be 0

Under process closed loop control or composite control, when the terminal is valid, the output frequency of the inverter process closed loop adjustment is forced to set as 0.

68: PID positive or negative function

PID is positive function at default. It needed negative function when feedback value is greater than reference value and the frequency needed increase. This function can realized through setting P8.09=1 or multi-function terminal function setting as 68.

P8.09=0, Terminal function is invalid: Positive;

P8.09=1, Terminal function is valid: Positive;

P8.09=1, Terminal function is invalid: Negative;

P8.09=0, Terminal function is valid: Negative.

69 to 98: Reserved

P5.07	X1 to X7 terminal filtering time	0.000~1.000 s(0.001s)
-------	----------------------------------	-----------------------

It can properly enlarge the setup value of P5.07 to improve the anti-interference capability of the terminal. The longer the terminal filter time is, the longer the delay time of the terminal action is.

P5.10	Maximum input pulse frequency	0.1~ 50.0 kHz (10.0 kHz)
-------	-------------------------------	--------------------------

When the pulse input of the multifunctional input terminal X7/DI acts as open loop frequency reference or analog feedback close loop reference (e.g. P0.04=4 or P1.02=4), the maximum input pulse frequency determined via this functional code.

When the pulse input acts as open loop frequency reference, maximum input pulse frequency P5.10 corresponds to maximum output frequency P0.11, the current pulse input frequency f_p and open loop frequency reference f can be calculated as per the following formula: $f=f_p \times P0.11 / P5.10$.

When the pulse input acts as close loop frequency reference, maximum input pulse frequency P5.10 corresponds to maximum digital voltage reference 10V, the current pulse input frequency f_p and analog feedback close loop reference V_p can be calculated as per the following formula: $V_p = f_p \times 10V / P5.10$.

P5.11	Startup/stop mode Selection	0 ~ 3(0)
-------	-----------------------------	----------

P5.11 is used to set the mode of controlling the startup and stop of the inverter with FWD and REV terminals in the terminal running command reference mode.

0: Two line 1;

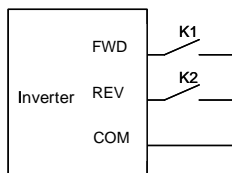

FWD	REV	Start-up and stop command
0	0	Stop
0	1	Reverse rotation
1	0	Forward rotation
1	1	Stop

Fig.6-14 Two-line running mode 1

1: Two line 2;

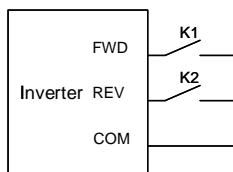

FWD	REV	Start-up and Stop command
0	0	Stop
0	1	Stop
1	0	Forward rotation
1	1	Reverse rotation

Fig.6-15 Two-line running mode 2

2: Three line 1;

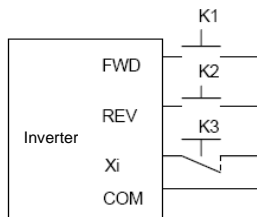

Fig.6-16 Three-line running mode 1

The terminal Xi(i=1~7) has set "4: Three-line mode rotation control" function.

Fig 6-16,when K3 is closed, FWD and REV controls are enabled; when K3 is disconnected, FWD and REV controls are disabled and the inverter stop.

The rising edge of FWD terminal means forward rotation command, while the rising edge of REV terminal means reverse rotation command.

3: Three line 2

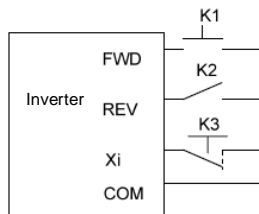

Fig.6-17 Three-line running mode 2

The terminal Xi (i=1~7) has set “4: Three-line mode rotation control” function.

Fig 6-17 when K3 is closed, FWD and REV controls are enabled; when K3 is disconnected, FWD and REV controls are disabled and the inverter stops.

The rising edge of FWD terminal means rotation command; the disconnection of REV terminal means forward rotation command, while the connection of REV terminal means reverse rotation command.

P5.12	Preset counting value reference	0 ~ 9999(0)
P5.13	Reached counting value reference	0 ~ 9999(0)

When the pulse signal counting of the terminal input complies with the preset condition, the terminal Yi will output corresponding instructions. The setting procedures are as follows:

1. Set Xi (i=1 to 7) terminal to “28: Counter trigger input”, and meanwhile set P5.12 and P5.13 .such as P5.12=4 and P5.13=8 .

2. The terminal Yi is set to “10: Preset counting value action”, and the action sequence is shown as Out1 in Fig.6-18. Effective level will be output when the counting value is between the values of P5.12 and P5.13.

The terminal Yi is set to “11: Reaching counting value action”, and the action sequence is shown as Out2 in Fig.6-18. Effective level will be output and kept till the counting value changes when the counting value reaches the value of P5.13.

Note:

- ◆ P5.12 cannot be set to a value of higher than P5.13, and the counter pulse signal frequency range is 0Hz to 200Hz. The voltage range is 24V±20%.
- ◆ Set Xi (ii=1 to 7) terminal to “29: Counter trigger reset”, and reset the counting value when the terminal Xi is enabled.

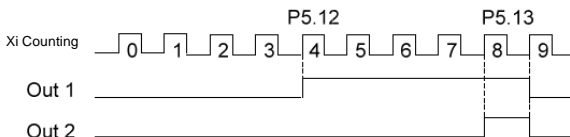

Fig.6-18 Schematic diagram for the preset and reaching counting value reference

6.7 Analog Reference Parameter (Group P6)

P6.00

AI1 to AI3 and DI analog value input curve selection

0~ 4444 (4444)

This function is used to perform calibration on the signals that are input via different input channels with different analog input curves.

Display of operation panel	
Unit's digit	AI1: 0: Determine the reference frequency (P6.01 ~ P6.04) by Curve 1 1: Determine the reference frequency (P6.05 ~ P6.08) by Curve 2 2: Per unit value determined by curve 3 (P6.09 to P6.12); 3: Per unit value determined by curve 4(P6.13 to P6.20); 4: Calibration by curve is not necessary
Tens place	AI2: The same as above
Hundreds place	AI3: The same as above
Thousands place	DI: The same as above

Curve 1 and curve 2 can be used to directly realize the corresponding relationship between analog value and setup frequency, while curve 3 and curve 4 can be used to convert the externally input analog value into analog values inside the inverter. The analog value selection is determined by P6.21.

Note:

- ◆ The running and stop display parameters AI1 ~ AI3 and DI determined by P2.02 and P2.03 all refer to the analog values inside the inverter, of which DI input is calculated on the basis of 10V corresponding to the maximum input pulse frequency P5.10.
- ◆ When current analog value input is selected, please refer to Fig.6-20.
- ◆ When "Calibration by curve is not necessary" is selected, the maximum analog input or maximum input pulse frequency corresponds to the maximum output frequency P0.11 or 100% per-unit value of the inverter.

P6.01	Curve 1 input point A0	0.0 ~110.0 %(0.0%)
P6.02	Reference frequency f0 corresponding to curve 1 input point A0	0.00~ 300.00 Hz(0.00Hz)
P6.03	Curve 1 input point A1	0.0 ~110.0 %(100.0%)
P6.04	Reference frequency f1 corresponding to curve 1 input point A1	0.00 ~ 300.00 Hz(50.00Hz)
P6.05	Curve 2 input point A0	0.0 ~110.0 %(0.0%)
P6.06	Reference frequency f0 corresponding to curve 2 input point A0	0.00 ~300.00 Hz(0.00%)
P6.07	Curve 2 input point A1	0.0 ~110.0 %(100.0%)
P6.08	Reference frequency f1 corresponding to curve 2 input point A1	0.00 ~ 300.00 Hz(50.00Hz)

Since the using methods of curve 1 and curve 2 are identical, Curve 1 is described as an example here. Both curve 1 and curve 2 can be used in process open loop analog frequency reference, and the running frequency of the inverter can be determined by the analog values AI1, AI2 and AI3 and DI pulse frequency reference. The conversion relationship between analog value and setup frequency is as shown in the figures below:

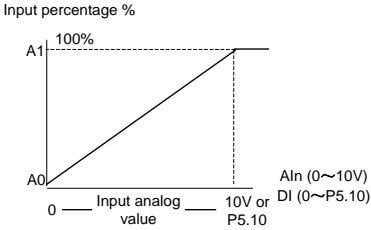

Fig.6-19 Corresponding percentage of input analog value (voltage/frequency)

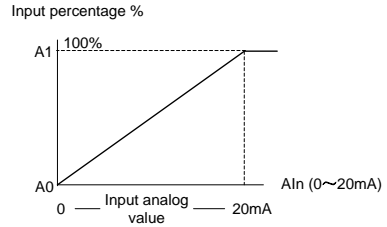

Fig.6-20 Corresponding percentage of input analog value (current)

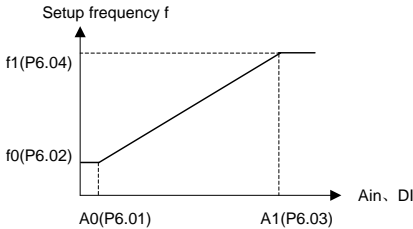

Fig.6-21 Setup frequency characteristics curve (positive effect)

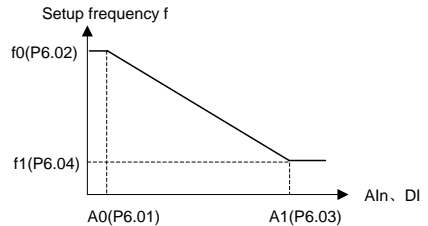

Fig.6-22 Setup frequency characteristics curve (negative effect)

P6.09	Curve 3 input point A0	0.0~110.0%(0.0%)
P6.10	Per-unit value B0 corresponding to curve 3 input point A0	0.0~110.0%(0.0%)
P6.11	Curve 3 input point A1	0.0~110.0%(100.0%)
P6.12	Per-unit value B1 corresponding to curve 3 input point A1	0.0~110.0%(100.0%)
P6.13	Curve 4 input point A0	0.0~110.0%(0.0%)
P6.14	Per-unit value B0 corresponding to curve 4 input point A0	0.0~110.0%(0.0%)
P6.15	Curve 4 input point A1	0.0~110.0%(25.0%)
P6.16	Per-unit value B1 corresponding to curve 4 input point A1	0.0~110.0%(25.0%)
P6.17	Curve 4 input point A2	0.0~110.0%(50.0%)
P6.18	Per-unit value B2 corresponding to curve 4 input point A2	0.0~110.0%(50.0%)
P6.19	Curve 4 input point A3	0.0~110.0%(100.0%)
P6.20	Per-unit I value B3 corresponding to curve 4 input point A3	0.0~110.0%(100.0%)

Curve 3 and curve 4 are basically the same, but that curve 4 has two more setting points than curve 3. The

input analog characteristics curve as shown in Fig.6-23. Curve 4 is described as an example here. Curves 3 and 4 convert the externally input analog into the equipment analog. All the AI and DI inputs will be reduced according to the relationship according to 10V correspondence to 100% per unit value. The function of per-unit value is determined by the analog channel function selection P6.21.

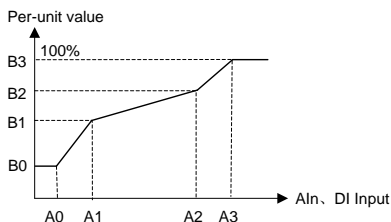

Fig 6-23 Input analog characteristics curve

P6.21

A1~A13. DI analog channel function selection

0~ 6666(0000)

Display of operation panel	
Unit's digit	A11 function selection 0: Open loop frequency or close loop rotation speed reference; 1 Torque reference 1 (torque control operation mode); 2: Torque reference 2 (torque control operation mode); 3: Reserved; 4: Reserved; 5: Motor temperature feedback (overload protection sensor mode); 6: Speed limiting (torque control operation mode)
Tens place	A11 function selection, the same as above;
Hundreds place	A13 function selection, the same as above;
Thousands place	DI function selection, the same as above

P6.21 is used to select functions of A11, A12, A13 and DI terminals. Since the using methods of A11, A12, A13 and DI are identical, A11 is described as an example here:

0: Open loop frequency or analog close loop rotation velocity reference: A11 analog input is converted into setup frequency via the analog curve.

1: Torque reference 1: Determine the torque reference with the per-unit value converted from analog.

0 to 100% per-unit value corresponds to 0 to 200% positive torque input, as shown in the positive axis zone in Fig.6-24.

When A13 channel is used to input -10V to 10V, the per-unit value converted from input analog -100% to 100% corresponds to the -200% to 200% of the torque input in positive and negative directions, as

shown in the positive and negative axis zone in Fig.6-24.

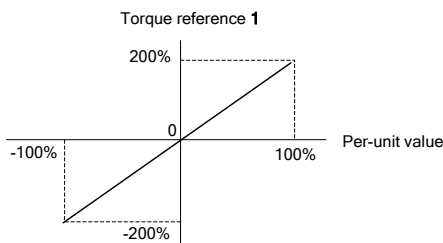

Fig.6-24 Torque reference 1

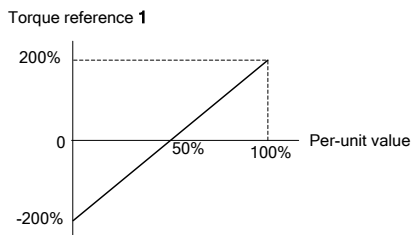

Fig.6-25 Torque reference 2

2: Torque reference 2: Determine the torque reference with the per-unit value converted from analog. The 0 to 100% per-unit value A is subject to internal correction of $(A-50\%) \times 2$, and then corresponds to -200% to 200% of the torque input in positive and negative directions, as shown in Fig.6-25.

Note: When AI3 channel is used to input 0 to 10V, torque reference 2 can be used. When AI3 is used to input -10V to 10V, torque reference 1 shall be used.

3: Reserved

4: Reserved

5: Motor temperature feedback: It is used together with P9.17 sensor protection threshold to report motor thermal protection alarm.

6: Speed limiting: Valid upon torque control. The per-unit value converted from analog is used to determine the speed limiting upon torque control operation. 0 to 100% per-unit value corresponds to 0 to maximum speed limiting input. This function is valid for both forward and reverse running directions. If the analog channel function has not been set as speed limiting upon torque control, the speed limiting value shall adopt the value set in Pd.06 and Pd.07.

Note: If the analog channel function is set to non-zero value, please make sure that different analog channels have different functions.

P6.22	AI1 filtering time	0.000~1.000 s(0.004s)
P6.23	AI2 filtering time	0.000~1.000 s(0.004s)
P6.24	AI3 filtering time	0.000~1.000 s(0.004s)

In field applications, the analog values input via AI1, AI2 and AI3 terminals usually have certain interference signals. It can enlarge the setup value of AI filter time properly to improve the anti-interference capability of the terminal input. However, the longer the filtering time of the terminal is, the longer the delay for the response to the action of the terminal is.

6.8 Multi-function Output Parameter (Group P7)

P7.00	Y1 terminal output function selection	0 ~ 47(0)
P7.01	Y2/DO terminal output function selection	0 ~ 71(1)
P7.02	Relay terminal output function selection	0 ~47(14)
P7.03	AO1 terminal output function selection	48~ 71(48)
P7.04	AO2 terminal output function selection	48 ~ 71(49)

Y1 and relay terminals can be defined as multifunctional digital signal output. AO1 and AO2 terminals can be defined as multifunctional analog value output, and the analog value type (0 ~ 10V/0 ~ 20mA) can be selected via the jumper.

The terminal Y2 can act as both multifunctional digital signal output and high-speed pulse output (0 ~ 50kHz).

The definition table of multifunctional digital signal output is as follows:

Function setup	Meaning	Function setup	Meaning
0	Signal indicating that the inverter is running (RUN)	1	Frequency arrival signal (FAR)
2	Frequency level detection signal 1(FDT1)	3	Frequency level detection signal 2(FDT2)
4	Pre-warning signal indicating inverter or motor overload (OL)	5	Stop and lock due to under voltage (LU)
6	Stop due to external failure (EXT)	7	Frequency upper limit(FHL)
8	Frequency lower limit(FLL)	9	Inverter is running at zero speed
10	Preset counting value action	11	Counting value arrival action
12	Reserved	13	End of Inverter ready for operation (RDY)
14	Inverter failure	15	Inverter reports alarm
16~18	Reserved	19	Output X1
20	Output X2	21	Reserved
22	Zero current detection arrival (relative to motor)	23	Stop command indication
24~47	Reserved		

0: Signal indicating that the inverter is running (RUN)

The signal is enabled when the inverter is running.

1: Frequency arrival signal (FAR)

When the deviation between the output frequency and the setup frequency of the inverter is in the setup range of the frequency arrival detection width, the signal is enabled. Refer to P7.19 for details.

2: Frequency level detection signal (FDT1)

When the output frequency of the inverter is higher than FDT1 level upper limit, the signal is enabled. When the output frequency less than FDT1 level lower limit, the signal is disabled. Refer to P7.20 ~ P7.21 for details.

3: Frequency level detection signal (FDT2)

When the output frequency of the inverter is higher than FDT2 level upper limit, the signal is enabled.

When the output frequency less than FDT2 level lower limit, the signal is disabled. Refer to P7.22 ~ P7.23 for details.

4: Pre-warning signal indicating inverter overload or motor overload (OL)

When the output current is higher than the overload pre-warning detection level and the retention time is higher than the overload pre-warning detection time, the signal is enabled. When the current is lower than the detection level, the signal is disabled. Refer to PA13 ~ PA.15 for details.

5: Stop and lock due to under voltage (LU)

When the inverter bus voltage is lower than the under voltage action value, the signal is enabled.

6: Stop due to external failure(EXT)

When the inverter is in the protection status due to failure of peripherals ("E.oUt" appears on the operation panel), the signal is enabled.

7: Frequency upper limit (FHL)

When the output frequency of the inverter reaches setup frequency upper limit, the signal is enabled.

8: Frequency lower limit (FLL)

When the output frequency of the inverter reaches setup frequency lower limit, the signal is enabled.

9: Inverter is running at zero speed.

When the output frequency of the inverter is 0, the signal is enabled.

10: Preset counting value action

11: Counting value arrival action

When the counting value of inverter input terminal complies with action, the signal is enabled, Refer to P5.12 and P5.13 for details.

13: Inverter ready for operation (RDY)

When the auto-test of the inverter is normal after power on and the inverter operation disable function is invalid or disable, the signal is enabled.

14: Inverter fault

When the inverter is in the stop status due to failure, the signal is enabled.

15: Inverter reports alarm

When the inverter is in the alarm status due to fault but does not stop, the signal is enabled.

19: Output X1

When the status of multifunctional input X1 terminal is output via the terminal Y, when X1 is enabled, the signal is enabled.

20: Output X2

When the status of multifunctional input X2 terminal is output via the terminal Y, when X2 is enabled, the signal is enabled.

22: Zero current detection arrival

When the output current of the inverter is lower than the zero current detection width during operation, the signal is enabled. Refer to P7.18 for details.

23: Stop command instruction

When the inverter is in the stop or standby status, the signal is enabled.

12, 16, 17, 18, 21 and 24 ~ 47: Reserved

The definition table of multifunctional analog output and pulse output is as follows:

Function setup	Output signal selection	Definition of analog output range	Definition of pulse output range
48	Output frequency	Maximum frequency P0.11 corresponds to 10V/20mA.	Maximum frequency P0.11 corresponds to P7.10.
49	Setup frequency	Maximum frequency P0.11 corresponds to 10V/20mA.	Maximum frequency P0.11 corresponds to P7.10
50	Output current	Two times rated current of inverter corresponds to 10V/20mA.	Two times rated current of inverter corresponds to P7.10
51	Motor current	Two times rated current of motor corresponds to 10V/20mA	Two times rated current of motor corresponds to P7.10.
52	Output torque	Two times rated torque of motor corresponds to 10V/20mA.	Two times rated torque of motor corresponds to P7.10
53	Output voltage	Two times maximum output voltage P0.12 corresponds to 10V/20mA.	Two times maximum output voltage P0.12 corresponds to P7.10
54	Bus voltage	1000V corresponds to 10V/20mA	1000V corresponds to P7.10.
55	AI1	10V corresponds to 10V/20mA; 20mA corresponds to 5V/10mA.	10V corresponds to P7.10; 20mA corresponds to 50% of P7.10.
56	AI2	The same as AI1	The same as AI1.
57	AI3	-10V ~ 10V corresponds to 0 ~ 10V/20mA.	-10V ~ 10V corresponds to 0 ~ P7.10.
58	DI	Maximum input pulse frequency P5.10 corresponds to 10V/20mA.	Maximum input pulse frequency P5.10 corresponds to P7.10
59	Output power	2 times rated output power of motor corresponds to 10V/20mA.	2 times rated output power of motor corresponds to P7.10.
60	Host computer percentage	10000 corresponds to 10V/20mA.	10000 correspond to P7.10.
61	Heatsink temperature	0 to 100°C corresponds to 0 to 10V/20mA	100°C corresponds to P7.10
62	Output frequency 2	Maximum frequency P0.11 corresponds to 10V/20mA	Maximum frequency P0.11 corresponds to 10V/20mA
63~71	Reserved		

Note: Output frequency indicate the output frequency of inverter, Output frequency 2 indicate the frequency calculate by motor rotate speed.

P7.05	AO1 gain	0.0 ~ 200.0 %(100.0%)
P7.06	AO1 bias	0.0 ~ 200.0 %(0.0%)
P7.07	AO2 gain	0.0 ~ 200.0 %(100.0%)
P7.08	AO2 bias	0.0 ~ 200.0 %(0.0%)
P7.09	Selection of positive and negative gain and bias	0000~1111(0000)

To adjust the analog outputs as defined in the above table, it can use this function. The adjusted analog value is the actual output of AO terminal.

P7.09 is used to determine the positive and negative polarity of the gain or bias.

Display of operation panel	
Unit place	AO1 gain 0: Positive; 1: Negative
Tens place	AO1 bias 0: Positive; 1: Negative
Hundreds place	AO2 gain 0: Positive; 1: Negative
Thousands place	AO2 bias 0: Positive; 1: Negative

Since function codes P7.05 ~ P7.09 are different from other function codes, adjustment will affect the AO output timely.

Both AO1 and AO2 have the same calibration way. Take AO1 as an example:

Set P7.05 to 100.0% and P7.06 to 20.0%, namely, $K=1$ and $b=2V$, and the AO1 characteristics curve is as shown in Fig.6-26 and Fig.6-27.

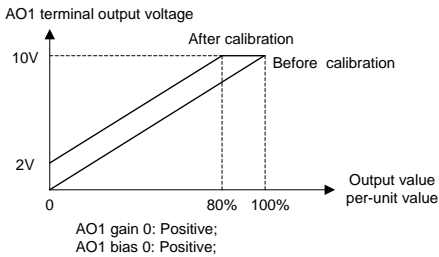

Fig.6-26 AO1 Characteristics Curve $Kx+b$

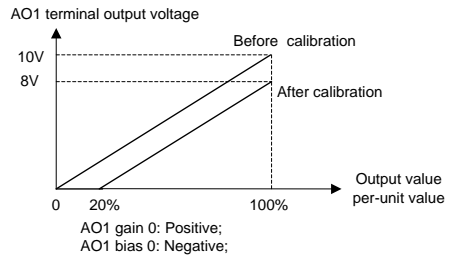

Fig.6-27 AO1 Characteristics Curve $Kx-b$

Set P7.05 to 100.0% and P7.06 to 120.0%, namely, $K=1$ and $b=12V$, and the AO1 characteristics curve is as shown in Fig.6-28.

Set P7.05 to 100.0% and P7.06 to 80.0%, namely, $K=1$ and $b=8V$, and the AO1 characteristics curve is as shown in Fig.6-29.

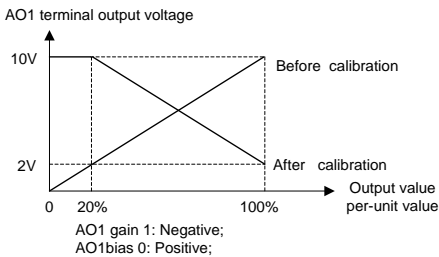

Fig.6-28 AO1 Characteristics Curve $-Kx+b$

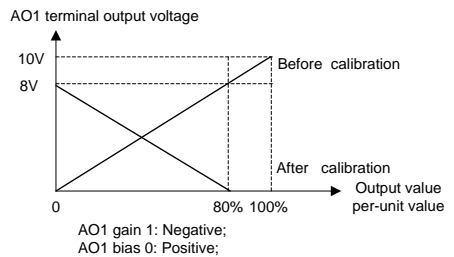

Fig.6-29 AO1 Characteristics Curve $-Kx-b$

Note: When the analog output gain is set to negative value and the bias is also negative, the AO output

will be limited to 0V automatically.

P7.10	Y2/DO Maximum output pulse frequency	0.1~50.0 kHz(10.0kHz)
-------	--------------------------------------	-----------------------

This function code determines the maximum frequency output by the terminal Y2/DO. Refer to P7.01 for details.

P7.18	Zero current detection width	0.0~ 50.0 %(0.0%)
-------	------------------------------	-------------------

This function can be used for load change detection. Once the output terminal is set to "22: Zero Current Detection Arrival", indication signal will be output upon the inverter output current is lower than the zero current detection width P7.18.

Note: This function parameter is percentage of the inverter output current to rated current of the motor.

P7.19	Frequency arrival detection width	0.00 ~ 300.00 Hz(2.5Hz)
-------	-----------------------------------	-------------------------

This function is used for detecting the deviation between output frequency and setup frequency. Once the output terminal function is set to "1: Frequency Arrival Signal", the deviation between the output frequency and the setup frequency of the inverter is in the setup range of this function code and indication signal is output, as shown in Fig.6-30 Frequency Arrival Signal FAR.

Yi represents Y1 terminal, Y2 terminal or relay terminal.

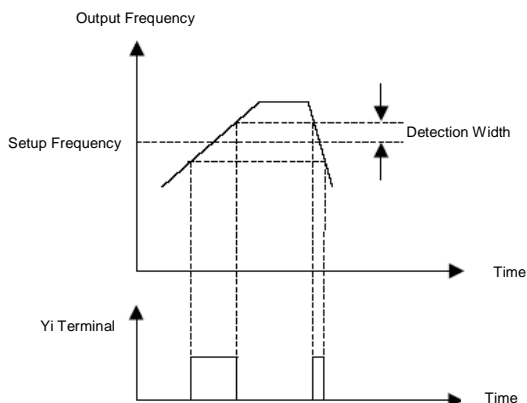

Fig.6-30: Frequency arrival signal (FAR)

P7.20	FDT1 level upper limit	0.00 ~ 300.00 Hz(50.00Hz)
P7.21	FDT1 level lower limit	0.00 ~300.00 Hz(49.00Hz)
P7.22	FDT2 level upper limit	0.00 ~ 300.00 Hz(25.0Hz)
P7.23	FDT2 level lower limit	0.00 ~ 300.00 Hz(24.00Hz)

This function is used for detecting whether the output frequency is within the setup FDT. The output terminal function is set to "2: Frequency level detection signal 1" or "3: Frequency level detection signal 2", the output frequency is in the corresponding FDT setup range and indication signal is output.

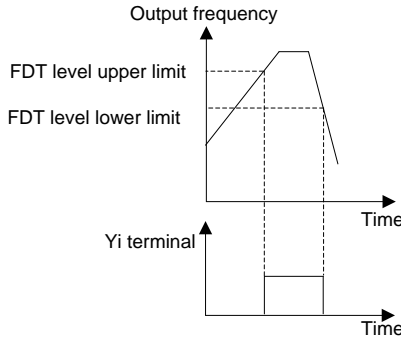

Fig.6-31: Frequency level detection signal (FDT)

P7.24

Virtual terminal effective selection

000 ~ 111(000)

It controls the action of the multifunctional input terminal or output terminal by the host computer.

Display of operation panel	
Unit place	Multifunctional input terminal Xi 0: The real terminal is enabled; 1: The virtual terminal is enabled
Tens place	reserved
Hundreds place	Y1, Y2 and relay terminals 0: The real terminal is enabled; 1: The virtual terminal is enabled

When Xi terminal signal source is input as virtual terminal, whether the corresponding function of this terminal is effective depends on the control of the host computer and has nothing to do with the real status of the current Xi terminal.

When Yi, Y2 and relay terminals are output as virtual terminals, the real outputs of these terminals depend on the control of the host computer and have nothing to do with whether the output terminal function set is effective.

P7.25

Terminal effective status selection

000 ~ 111(000)

It defines the validity of the input and output status of the multifunctional digital terminals.

Display of operation panel	
Unit place	Multifunctional input terminal Xi 0: Current through Xi is valid; 1: No current through Xi is invalid
Tens place	Multifunctional output terminal Yi 0: Current through Yi is valid; 1: No current through Yi is invalid
Hundreds place	Relay output terminal 0: Enable in magnetizing status; 1: Enable in no magnetizing status

When the digital input Xi terminal and COM terminal are short circuited, it may judge whether the input

status is valid by whether there is current flowing in the terminals.

When the digital output Y_i terminal acts as open collector output, it may judge whether the output status is valid by whether there is current flowing in the terminal.

It may judge whether the output status is valid by whether the relay terminal is in the magnetizing status.

6.9 Process PID Close Loop Parameters (Group P8)

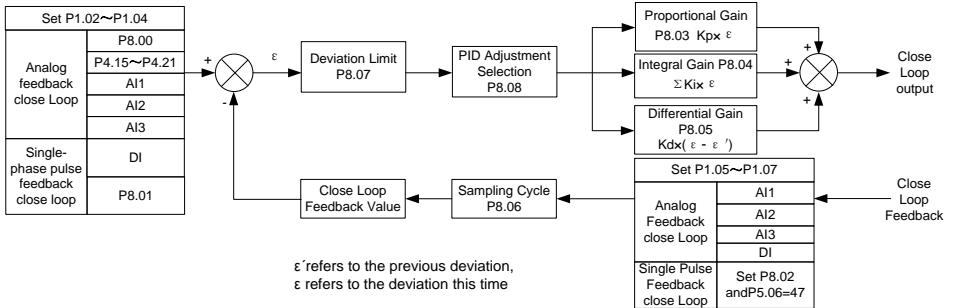

Fig. 6-32 Schematic diagram for PID

P8.00	Analog feedback process close loop control digital voltage reference	0.00~10.00 V(0.00V)
P8.01	Single-phase pulse feedback process close loop control digital rotation velocity reference	0~30000 rpm(0rpm)
P8.02	Number of pulses per turn for single-phase pulse	1~9999(1000)

The current control operation mode P0.03 shall be determined before determining the process close loop reference value.

When the current control operation mode is analog feedback process close loop (P0.03=1, 3, 5 and 7), if P1.02 is set to "0", it may determine the reference value of the close loop by P8.00. If P1.02 is non-zero value, it determine the reference value of the close loop by the analog value and pulse frequency selected in P1.02.

When the current control operation mode is single-phase pulse feedback process close loop (P0.03=2 and 6), it may determine the reference value of the close loop. In addition, when the single-phase pulse feedback process close loop is employed, it needs to use an pulse encoder and set the number of single-phase pulses per rotation for the encoder according to the encoder model (P8.02)so as to determine the close-loop feedback value indicated by the signal feedback by the single-phase pulse.

Note:

- ◆ The signal feedback by the single-phase pulse must be connected to X7/DI terminal and this terminal shall be set to "47: Single-Phase Pulse Input. of single-phase pulse feedback process close loop control.
- ◆ In the analog value feedback close loop mode, if P1.02 is set to "0", it can use multi-section

digital voltage reference to implement the multi-section reference function of the close loop. Refer to P4.15 ~ P4.21 for details.

P8.03	Proportional gain Kp	0.000 ~ 10.000(0.200)
P8.04	Integral gain Ki	0.000 ~ 10.000(0.500)
P8.05	Differential gain Kd	0.000 ~ 10.000(0.000)

As shown in Fig.6-32 PID Schematic Diagram, the higher the Kp value is, the faster the response is, but if the Kp value is too high, it may easily generate oscillation and the deviation cannot be eliminated completely. It can use Ki to eliminate the residual deviation. The higher the Ki value is, the faster the response of the inverter to the deviation change, but it may easily generate oscillation if the Ki value is too high. If the system has frequent feedback to the jump, it needs to use Kd because Kd can respond to the deviation change between the system feedback and the reference quickly. The higher the Kd value is, the faster the response is, but it may easily generate oscillation if the value is too high.

P8.06	Sampling cycle	0.001 ~ 30.000 s(0.002s)
-------	----------------	--------------------------

This function is used to set the sampling cycle of the feedback signal. The lower this parameter value is, the faster the response of the system to the deviation between the reference and the feedback, but if the sampling cycle is too fast, the associate requirement for the system PID gain adjustment will be higher, which may result in system oscillation.

P8.07	Deviation limit	0.0 ~ 20.0 %(5.0%)
-------	-----------------	--------------------

When this function determines the certain level of the deviation between the feedback signal and the reference signal, it will stop the internal PID adjustment and maintain stable output. Only when the deviation between the feedback value and the reference value of the close loop exceeds the deviation limit of P8.07 will the output be updated. Setting the deviation limit needs to take the system control precision and stability into consideration.

P8.08	PID adjustment selection	0 ~ 11(10)
-------	--------------------------	------------

This function determines the specific running mode during the process close loop adjustment.

Display of operation panel	
Unit place	Integration mode 0: Frequency reaches its upper limit and lower limit the integration adjustment is stopped; 1: Frequency reaches its upper limit and lower limit and the integration adjustment continues
Tens place	Output power 0: It must be consistent with the setup running direction. 1: It can be against the setup running direction

If the output value of the close loop adjustment reaches frequency upper limit or lower limit (P0.13 or P0.14), there are two actions for selection in the integration section.

0: Stop integration adjustment: the integration value remains unchanged. When there is change occurring to the deviation between the reference value and the feedback value, the integration value will follow that change trend.

1: Continue integration adjustment: The integration value will give immediate response to the change between the reference value and the feedback value unless this value reaches the internal integration limit. When there is change occurring to the deviation between the reference value and the feedback value changes, it needs to take longer time to offset the impact brought by the continuous integration so that the integration value can catch up that change trend.

If the output value of the close loop adjustment is inconsistent with the current setup running direction, the close loop output value has two actions for selection.

0: It must be consistent with the setup running direction: When the output value of the close loop adjustment is inconsistent with the current setup running direction, the current output value will be forced to be 0 internally.

1: It can be against the setup running direction: When the output value of the close loop adjustment is inconsistent with the current setup running direction, the close loop adjustment opposite to the current setup running direction will be executed.

P8.09

PID positive or negative function

0 ~ 1 (0)

PID is positive function at default. It needed negative function when feedback value is greater than reference value and the frequency needed increase. This function can realized through setting P8.09=1 or multi-function terminal function setting as 68.

P8.09=0, Terminal function is invalid: Positive;

P8.09=1, Terminal function is valid: Positive;

P8.09=1, Terminal function is invalid: Negative;

P8.09=0, Terminal function is valid: Negative.

P8.10

Reserved

0 ~ 65535 (0)

6.10 Motor Parameter (Group P9)

P9.00

Load Type

0 ~ 1(0)

This function is used to determine the motor load type driven by the inverter.

0: G-type constant torque/heavy-duty application

1: L-type variable torque/heavy-duty application

Once the load type is changed, P9.03 ~ P9.14 will change to the factory default setting automatically, while P3.01 and P3.07 will change to 0 automatically. When the load type is selected as 1, the current limit value PA.05 will change to 120% automatically, while the drive and brake torque limit values Pd.08 and Pd.09 will change to 135% automatically. When the load type is selected as 0, the current limit value PA.05 will change to 160% automatically, while the drive and brake torque limit value Pd.08 and Pd.09 will change to 180% automatically.

P9.01	Number of motor poles	2~ 24(4)
P9.02	Rated rotation velocity of motor	0 ~ 30000 rpm(1500rpm)
P9.03	Rated power of motor	0.4 ~ 999.9 kW(Factory)
P9.04	Rated current of motor	0.1 ~ 999.9 A(Factory)

P9.01 ~ P9.04 are used to set the motor parameters driven by the setup inverter and shall be set properly in accordance with the motor nameplate prior to the use.

Note: The power level of the inverter shall match the motor.

P9.05	Motor no-load current I0	0.1 ~ 999.9 A(Factory)
P9.06	Stator resistance R1	0.000 ~ 65.000 Ω(Factory)
P9.07	Stator inductance leakage L1	0.0 ~ 2000.0 mH(Factory)
P9.08	Rotor resistance R2	0.000 ~ 65.000 Ω(Factory)
P9.09	Mutual inductance L2	0.0 ~ 2000.0 mH(Factory)
P9.10	Magnetic saturation coefficient 1	0.00 ~ 100.00 %(Factory)
P9.11	Magnetic saturation coefficient 2	0.00 ~ 100.00 %(Factory)
P9.12	Magnetic saturation coefficient 3	0.00~100.00 %(Factory)
P9.13	Magnetic saturation coefficient 4	0.00~100.00 %(Factory)
P9.14	Magnetic saturation coefficient 5	0.00~100.00 %(Factory)
P9.15	Parameter auto-tuning	0~2(0)

It determines the key motor parameters affecting the running control of the inverter through implementing the parameter auto-tuning. These motor parameters will be stored in the inverter automatically upon completion of parameter auto-tuning process till next parameter input or another parameter auto-tuning.

The process of parameter auto-tuning is described as follows:

- ◆ Input P9.00 to P9.04 properly in accordance with the motor nameplate; set the basic running frequency P0.15, maximum output frequency P0.11 and maximum output voltage P0.12; set the acceleration/deceleration time P0.08 and P0.09 properly.

- ◆ Select the implementation mode of parameter auto-tuning P9.15:

1: Static parameter auto-tuning. Press the run key to measure the motor parameters P9.06 ~ P9.08 automatically. and P9.15 will be restored to 0 automatically upon completion of auto-tuning process.

2: Rotating parameter auto-tuning. Press the run key to measure the motor parameters P9.06 ~ P9.14 automatically. and P9.15 will be restored to 0 automatically upon completion of auto-tuning process.

Note:

- ◆ If the motor can be disconnected from the load, it can select rotation auto-tuning (P9.15=2), or it can select static auto-tuning only. Make sure that the motor is in the static status when starting

the parameter auto-tuning. If there is over current or over voltage failure during the auto-tuning process, it can prolong the acceleration/deceleration time P0.08 and P0.09 properly.

- ◆ If the inverter power does not match the motor power, select static auto-tuning. After the tuning, manually change the no load current P9.05 to about 40% of the motor rated current P9.04.
- ◆ If the motor parameters are given, please enter the parameters to P9.05 ~ P9.09 directly. If the motor parameters are not given, please execute the parameter auto-tuning. The magnetic saturation and coefficient value in P9.10 ~ P.14 is automatically set during auto-tuning, eliminating the need of setting by the user.
- ◆ During the process of parameter auto-tuning, “-At-“ will appear on the operation panel.

P9.16	Motor overload protection	00 ~ 12(00)
P9.17	Sensor protection threshold of motor	0.00 ~ 10.00 V(10.00V)
P9.18	Motor overload protection time	0.5 ~ 30.0 min(10.0min)

This function can be used to protect the motor.

Display of operation panel	
Unit place	Protection mode 0: Motor current mode; 1: Sensor mode; 2: No action
Tens place	Low speed derating 0. Action (applicable to common motor); 1. No action (applicable to variable frequency motor)

The unit's place of P9.16 determines whether the motor overload protection is to be executed and whether the motor overload protection employs current mode or sensor mode.

0: Motor current mode: Overload is calculated in accordance with motor current, running frequency and running time and compared with the allowable motor overload time determined by P9.18. Once the accumulated overload time is reached, the inverter will report “E.oL2” motor overload failure.

When the load type is constant torque (P9.00=0), the motor overload protection time P9.18 corresponds to the overload protection time under 150% rated load current and is 10 minutes by factory default; when the load type is variable torque (P9.00=1), the motor overload protection time P9.18 corresponds to the overload protection time under 115% of rated load current and is 10 minutes by factory default.

Note: The calculation of motor overload protection continues during the inverter running and stopping process, while the accumulated overload value will be reset when the inverter is power-off.

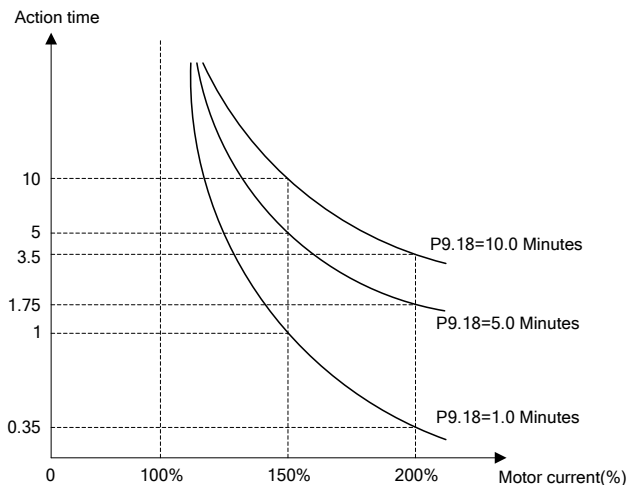

Fig.6-33 Motor Overload Protection Characteristics Curve (Constant Torque)

1: Sensor mode. Compare the analog feedback value of the thermal sensor installed on the motor with the present sensor protection threshold P9.17. If the feedback value is higher than that protection threshold, the inverter will report “E.Ptc” motor overheat failure immediately, without inverse time lag characteristics.

Note: When this protection mode is employed, it needs to select the input channel for the analog feedback value of the thermal sensor and confirm that the input function of this analog channel is selected as “5: Motor Temperature Feedback”.

2: No motor protection action, indicating that the inverter will not protect the overload status of the motor. It must be used with care.

Tens place of P9.16:

0: Action: The heat sink effect will become poorer when the motor is running at low speed and the motor is derated according to the motor overload protection time as determined in P9.18.

1: No action: For some special motors, such as variable frequency motor, “no action” can be selected when derating at low speed. It must be used with care.

6.11 Control Parameter (Group PA)

PA.00	Carrier frequency	0.7 ~ 16.0 kHz(Factory)
PA.01	Carrier frequency automatic adjustment selection	0 ~ 1(1)

Carrier frequency has an important impact on operations of inverter and motor. When carrier frequency increases, the loss, temperature rise and noise of motor will decrease. If carrier frequency decreases, the temperature rise of inverter itself as well as the leakage current of motor and its interference with external radiation will decrease.

PA.01 can be able to determine automatically the most suitable carrier frequency according to the temperature of inverter.

0: Non-auto adjustment, carrier frequency will not be adjusted automatically according to the temperature of inverter. Under favorable circumstances as regards ventilation and heat sink, all loads shall operate with low noise. Set PA.00 with higher carrier frequency and set PA.01 to 0.

1: Auto-adjustment; inverter can adjust automatically carrier frequency through temperature check according to the weight of load. Maintain continuously reliable operation by keeping operating with low noise at low loads and controlling the temperature of inverter at heavy load.

PA.02	Vector control 1 slip compensation gain	0.0 ~ 300.0 %(100.0%)
-------	---	-----------------------

The function will be enabled when operating under vector control 1 (when P0.03=0~3). The function will help the inverter to keep the motor rotational speed constant if loads vary or under heavy loads.

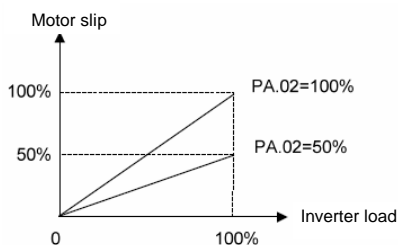

Fig. 6-34 Vector control 1 slip compensation gain

PA.03	Droop control	0.00 ~ 10.00 Hz(0.00Hz)
-------	---------------	-------------------------

When several inverters drive the same load, the function can distribute the load automatically between inverters and make them work cooperatively. For example, when some inverters run an assembly line, this function can be used to balance loads, allocate loads between inverters at different power levels in proportion to the power, and thus ensure the assembly line operate properly. Each inverter adjusts output frequency automatically according to its load condition and lifting ratio set by drooping control.

Note: This function is only applied to vector control 1.

PA.04	Current limit action selection	0~1(1)
PA.05	Current limit value	20.0~200.0 %(160.0%)

PA.04 current limit motion selection:

0: Invalid. Invalid for both processes of constant speed and acceleration/deceleration .

1: Valid. Valid for both processes of constant speed and acceleration/deceleration .

Generally, when setting speed or motor load varies sharply, output current of inverter may reach beyond over current protection value point, resulting over current error. Current limit function reduces effectively occurrences of over current errors as inverter controls instantaneous output current and keep the sharply changed output current below protective motion value, thus ensuring continuous and reliable operation of system. When current exceeds a certain value (PA.05), the inverter will turn into current limit status. When operating under constant speed, maintain stable load capability without producing over current error by current limit. When loads mitigate, exit the current limit status automatically, and return to work properly. The function is especially applied to applications of suddenly changed speed or load.

Note:

- ◆ Current limit current PA.05 is proportion of rated current of inverter. When torque load varies: 20.0~150.0%.
- ◆ This function is only applied to vector control 1.
- ◆ Under the current limit status, the speed of motor will decrease. The current limit function is not appropriate for systems that will not permit reduce speed, for example lifter, otherwise will loss of control.

PA.06	Voltage adjustment function	0 ~ 111(101)
-------	-----------------------------	--------------

Unit place: Over-voltage adjustment: When motor with large inertial load stops rapidly, or a short-time regenerative braking happens for load abrupt changes when the motor operates, DC bus voltage of inverter will rise, thus may result over-voltage protective motion. The function of voltage adjustment is in this case, decrease the braking torque to control the DC bus voltage to prevent over voltage alarm through adjust output frequency and auto prolong deceleration time.

Note: If energy-consumption braking is applied and braking unit (PA.09=1) has been set and applied, the function becomes invalid.

Tens place: Under-voltage adjustment: When power supply voltage decreases or instantaneous power-off; DC bus voltage will also decrease. The function of under-voltage adjustment is decrease the motor rotating speed through decrease the output frequency, the load inertial energy feedback to DC side to keep DC voltage higher than the under vantage value, avoid stop by under voltage. Under voltage function is very effective in applications such as centrifugal pump and fan.

Note: This function is only applied to vector control 1.

Hundreds place: Overmodulation: This function is used to increase output voltage of inverter and ensure the output capability of the inverter under low grid voltage or under heavy load.

Display of operation panel	
Unit place:	Over-voltage adjustment: 0: No action; 1: Action
Tens place	Under-voltage adjustment: 0: No action; 1: Action
Hundreds place	Overmodulation: 0: No action; 1: Action

PA.07	Energy-saving coefficient	0 ~ 50 %(0%)
-------	---------------------------	--------------

By setting PA07, ensure that output voltage will decrease automatically as the loads decrease under proper operation. The inverter maximally decreases reactive power to offer further energy savings. Adjust the parameter according to real load conditions. The larger the parameter is, more visible the energy saving effect achieves, and the longer the response time lasts for the inverter converting from energy saving condition to proper operation status.

Note:

- ◆ This function is only applied to Vector control 1.
- ◆ The function applies to variable torque loads such as fan and pump. If used in applications of constant torque loads and rapidly changing loads, the function will result delayed control response.
- ◆ This function is disabled during acceleration/deceleration process.

PA.08	Magnetic flux braking selection	0 ~ 1(1)
-------	---------------------------------	----------

0: Magnetic flux braking disable

1: Magnetic flux braking enable

When the motor decreases, the inverter can rapidly slow down if magnetic flux braking action is selected. Then the electric energy can be transformed to heat energy during the braking process.

Rapid deceleration can be realized by selecting magnetic flux braking action, but the output current will be larger. Selecting no action, the deceleration will last longer, but the output current will be smaller.

PA.09	Energy consumption braking selection	0 ~ 1(0)
-------	--------------------------------------	----------

Determine whether to use energy consumption braking using braking unit selection PA.09.

0: Energy consumption braking disable

1: Energy consumption braking enable

For large rotating inertia applications and when rapid stop by braking is required, select matched braking unit and braking resistance and set braking parameter for the motor stop rapidly by braking.

PA.10	Braking unit operating time	100.0 s(100.0s)
PA.11	Braking unit action voltage	650 ~ 750 V(720V)

Braking unit operating time PA.10 and braking unit action voltage PA.11 are only applied to inverter with built-in braking unit.

Braking unit action cycle is fixed to be 100s. If PA.09 is set as 1, the use rate of the braking unit is fixed to

100%. That is, the use time of the braking unit is fixed to 100.0s

Action voltage of braking unit can be selected by adjusting PA.11. The motor can be stopped rapidly by energy braking with the appropriate action voltage.

Note: Set PA.09 to 1 when using braking unit. For model selection of braking unit parts and connection, refer to 1.9 braking unit model selection.

PA.12	Relay action indication when the inverter is faulty.	0 ~ 111(000)
-------	--	--------------

Generally, when inverter produces a failure alarm, the relay will make corresponding indication action. With this function, the action of error relay terminal can be set under some special conditions.

Display of operation panel	
Unit place:	Under-voltage failure 0: Disable; 1: Enable
Tens place	Auto reset interval period 0: Disable; 1: Enable
Hundreds place	Failure locked 0: Disable; 1: Enable

Unit place: Under low-voltage status such as power-up or power failure, choose whether the failure indication to act or not.

Tens place: When the real failure is not displayed during auto reset period, choose whether the failure indication to act or not. Refer to PA.21 and PA.22 instructions.

Hundreds place: If failures lock function enabled, when locked failures during last power-failure are displayed after power-on again, choose whether the failure indication to act or not. Refer to PA.20 instruction.

PA.13	Inverter or motor overload prealarm	0 ~ 111(000)
PA.14	Overload prealarm detection level	20.0 ~ 200.0 %(130.0%)
PA.15	Overload prealarm detection time	0.1 ~ 60.0 s(5.0s)

Overload prealarm function can realize indication of pre-setting overload status or alarm stop. PA.13 determines overload prealarm detection volume and conditions.

Display of operation panel	
Unit place:	Detection volume selection 0: Motor overload prealarm, relative motor rated current; 1: Inverter overload prealarm, relative inverter rated current
Tens place	Action selection after overload prealarm 0: Continue to run; 1: Report overload failure and stop
Hundreds place	Detection conditions selection 0: Detection all the time; 1: Detection only at constant speed

Unit place: Determine overload detection is motor overload prealarm or inverter overload prealarm.

Tens place: Determine inverter continues to run or alarms then stops when the output current exceeds

continuously overload prealarm detection level PA.14 and the lasting time is longer than overload prealarm detection time PA.15. If tens place is selected with overload failure display and stop, it will display “E.oL2” when the unit place is 0, it will display “E.oL1” when the unit place is 1.

Hundreds place: Determine under which run status the overload prealarm function will be enabled.

Note: Y terminal with multiple function can be set to “4: Overload detection signal (OL)” to display overload prealarm signal.

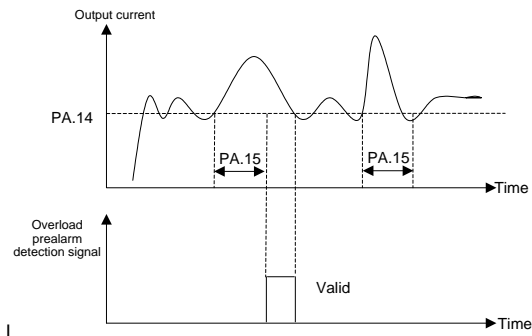

Fig. 6-35 Overload prealarm detection signal

PA.16	Fault shielded and alarm attribute setup 1	0 ~ 2222(0020)
PA.17	Fault shielded and alarm attribute setup 2	0 ~ 2222(0000)
PA.18	Fault shielded and alarm attribute setup 3	0 ~ 2222(2000)
PA.19	Fault shielded and alarm attribute setup 4	0 ~ 2222(0002)

The function can be used to manage various actions when some failures occur. When these failures occur under some special circumstances, inverter shall alarm immediately but not stop. Alarm information is displayed on the operational panel and even the failure is to be shielded.

Unit place, tens place, hundreds place and thousands place displayed on operational panels from PA.16 to PA.19 can be set:

- 0: Failure not shielded and alarm and stop during failure.
- 1: Failure not shielded and alarm but not stop during failure.
- 2: Failure shielded neither alarm nor stop.

Note: To change factory-setting, please contact with distributor or manufacturer.

PA.16 failure shield and alarm attribute setting 1

Display of operation panel	
Unit place:	Output short circuit to ground abnormality
Tens place	Power failure abnormality during running
Hundreds place	Input power abnormality
Thousands place	Output phase loss EEPROM abnormality

PA.17 failure shield and alarm attribute setting 2

Display of operational panel	
Unit place	EEPROM abnormality
Tens place	Relay contact abnormality
Hundreds place	Temperature sampling disconnection
Thousands place	Encoder disconnection

PA.18 Failure shield and alarm attribute setting 3

Display of operational panel	
Unit place	Abnormal +10V power supply output
Tens place	Abnormal analog input
Hundreds place	Motor over-temperature (PTC)
Thousands place	Abnormal communication1(operational panel 485)

PA.19 Failure shield and alarm attribute setting 4

Display of operational panel	
Unit place	Abnormal communication2(terminal 485)
Tens place	Abnormal version compatibility
Hundreds place	Reserved
Thousands place	Reserved

PA.20	Fault locking function selection	0 ~ 1(0)
-------	----------------------------------	----------

0: Failure lock disabled.

1: Failure lock enabled: Allowing re-display defaults occurred upon last power failure after power-on properly run only after resetting failure.

Note:

- ◆ Whether to output failure indication at the same time is decided by action indication of fault relay of inverter. Refer to PA.12 instruction.
- ◆ LU under-voltage cannot be locked upon next time power-up of the inverter as failure.

PA.21	Automatic reset times	0 ~ 20(0)
PA.22	Automatic reset interval	2.0 ~ 20.0 s(2.0s)

The function can be used to auto reset from ordinary failures. The inverter will start to run automatically again after auto reset interval period PA.22. If the failure still exists as the inverter starts again after auto reset times PA.21, it will alarm then stop. For defaults such as overcurrent or overvoltage occurred occasionally from beginning or during running, the function can be used if you want the equipment keep running without manual interfere.

Note: For fault E.PCU, E.rEF, E.AUt, E.FAL, E.oUt, E.ot1, E.ot2, E.Cur, E.GdF, E.LV1, E.CPy, E.dL4, E.loF and E.oL3, there has no auto reset function. The inverter will not check fault.

6.12 Enhanced Function Parameter (Group Pb)

Pb.00	Hopping frequency 1 lower limit	0.00 ~ 300.00 Hz(0.00Hz)
Pb.01	Hopping frequency 1 upper limit	0.00 ~ 300.00 Hz(0.00Hz)
Pb.02	Hopping frequency 2 lower limit	0.00 ~ 300.00 Hz(0.00Hz)
Pb.03	Hopping frequency 2 upper limit	0.00 ~ 300.00 Hz(0.00Hz)
Pb.04	Hopping frequency 3 lower limit	0.00 ~ 300.00 Hz(0.00Hz)
Pb.05	Hopping frequency 3 upper limit	0.00 ~ 300.00 Hz(0.00Hz)

Set hopping frequency range of inverter to avoid mechanical resonance. When the setting frequency of inverter is less than the hopping frequency, the inverter will run automatically at the upper limit or lower limit of the hopping frequency (change to run at lower limit of the hopping frequency when acceleration, for deceleration, change to run at upper limit of the hopping frequency), as shown in Fig. 6-36.

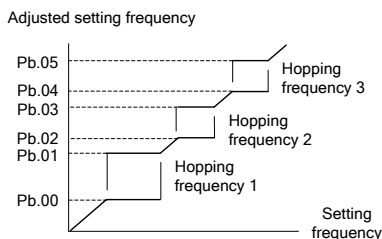

Fig. 6-36 Upper and lower limit of hopping frequency

Pb.06	Single step without integral function	0.00~10.00Hz(0.1Hz)
-------	---------------------------------------	---------------------

When Pb.08 and Pb.10 setting without integral function, UP/DN single step increase or decrease frequency define by Pb.06.

Pb.07	Magnification selection	0~01(00)
-------	-------------------------	----------

Display of operational panel	
Unit place	Acceleration/deceleration time 0:x1; 1:x10
Tens place	Reserved

For some special applications that longer acceleration/deceleration time is required, the function can be used to determine magnification of acceleration/deceleration time that has been set. For example, if the current acceleration/deceleration time 0(P0.08, P0.09) is valid, the real applied acceleration/deceleration time is 10 times as long as acceleration/deceleration time 0 when x10 is selected.

Pb.08	Operational panel \wedge / \vee digital regulating frequency control	0~0221(0001)
Pb.09	Operational panel \wedge / \vee integral rate	0.1~50.0 s(2.0s)

Setting with operational panel Δ/V regulating frequency can be realized by the function. When the operational panel is in the parameter display state of operation or stop, through operational panel Δ/V to regulate frequency is the most direct and convenient way. Frequency value will save in the inverter and superimposed on other frequency as final frequency.

Operational panel Δ/V digital regulating frequency control Pb.08 determines the function of operation panel Δ/V adjustment volume.

Operational panel Δ/V integral rate Pb.09 determines the time it will take to refresh increment/decrement for one time when adjusting with Δ/V .

Display of operational panel	
Unit place	Action when power failure 0: mains loss save; 1: reset upon mains loss
Tens place	Action when stop 0: Maintain when stop; 1: Reset clear when deceleration or stop; 3: Reset during standby
Hundreds place	Operational panel Δ/V regulation setting 0: Only valid when main reference is P0.05 open loop digital frequency setting 1: Valid during adjustment; 2: Invalid during adjustment
Thousands place	0: With integral function; 1: Without integral function

Unit place: Action upon mains loss

0: After setting frequency by operational panel Δ/V adjustment, operational panel Δ/V adjustment volume will be recorded automatically after power to the inverter is cut off.

1: After setting frequency by operational panel Δ/V adjustment, operational panel Δ/V adjustment volume will be cleared automatically after power to the inverter is cut off.

Tens place: Action during shutdown

0: After shutdown, adjustment volume of Δ/V on operational panel keeps unchanged.

1: After shutdown, adjustment volume of Δ/V on operational panel will be cleared after carrying out stop command.

2: After shutdown, adjustment volume of Δ/V on operational panel is cleared under the stop status. Frequency cannot set by Δ/V under the stop status.

Hundreds place: Setting of Δ/V on operational panel

0: Only valid when the main reference is P0.05 open loop digital frequency setting (P0.04=0).

1: Valid under all frequency reference modes (P0.04 not specified).

2: Operational panel adjustment Δ/V disabled.

Thousands place: Setting of Δ/V on operational panel

0: With integral function. When the operation panel Δ/V adjustment is used to set the frequency, the consistent adjustment in one direction has integral effect. The step length of adjustment starts from 0.01Hz, after every 10 times of adjustment, the step length will be increased by 10 times, and the

maximum step length of adjustment is 1.00Hz.

1: Without integral function. When the operation panel \wedge/\vee adjustment is used to set the frequency, the step length of the adjustment is fixed to 0.1Hz.

Note: When operating under process closed loop PID, the closed loop reference also can be adjusted with operational panel \wedge/\vee . Then adjustment volume of \wedge/\vee is regarded as analog superimposed upon closed loop reference. The minimum step size is 1mV.

Pb.10	Terminal UP/DN digital regulating frequency control	0~1221(0001)
Pb.11	Terminal UP/DN integral rate	0.1~50.0 s(2.0s)

Display of operational panel	
Unit place	Action when power failure 0: Mains loss save; 1: Zero clearing upon mains loss
Tens place	Action when shutdown 0: Maintained when shutdown; 1: Reset when deceleration shutdown; 2: Reset when standby
Hundreds place	Terminal UP/DN regulation setting 0: Only valid when main reference is P0.05 open loop digital frequency setting; 1: Valid during adjustment; 2: Invalid during adjustment
Thousands place	0: With integral function; 1: Without integral function

Pb.10 and Pb.11 are the same as the usage of operational panel \wedge/\vee . For functions of terminal UP/DN, refer to instructions of P5.00~P5.06.

Pb.15	Restart automatically after power resumes normal	0~1(0)
Pb.16	Waiting time for restart	0.0~20.0 s (05.s)

0: No action after power resumes normal.

1: Action after power resumes normal.

The function supports automatic operation of the inverter upon power resume normal after power failure. Be careful in using this function.

When restart after power failure is selected, the inverter will operate automatically after power on under any operating command reference mode, such as operation panel operating command reference, terminal operating command reference or host computer operating command reference.

When restart after power failure is selected, if P0.06=1 and the running terminal is enable when power on, the inverter will be run after power resumes normal.

Note: To ensure this function is valid under terminal operating command reference mode, please do not change the status of operating command terminal during shutdown.

Pb.17	Pre-set frequency	0.00~300.00 Hz (0.00Hz)
Pb.18	Pre-set frequency operating time	0.0~3600.0 s(0.0s)

When the inverter operates, the function can response the setting of reference channel for other frequencies after using the pre-set frequency as the setting frequency and keeping the time as pre-set frequency operating time Pb.18.

Pb.19	Upper limit of zero frequency operation	0.00~300.00 Hz(0.00Hz)
Pb.20	Lower limit of zero frequency operation	0.00~300.00 Hz(0.00Hz)

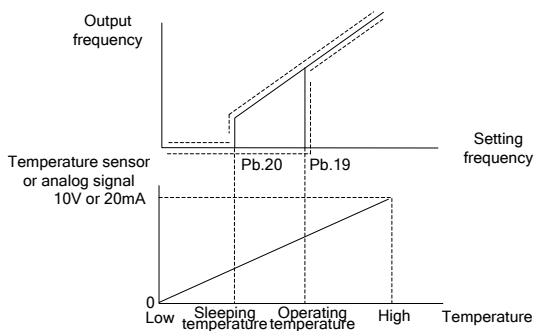

Fig. 6-37 Upper and lower limit of zero frequency operation

This function supports sleep function and energy saving operation. After running, the inverter will start when the setting frequency \geq Pb.19. During operation, the inverter operates at zero frequency when the setting frequency \leq Pb.20. Proper setting of limit value of zero operation can avoid the inverter starting and stopping frequently. If the inverter is often used for work situations such as air condition and fan, change the analog signal of temperature sensor to setting frequency to control automatic starting or stopping of inverter. See Fig. 6-37.

Pb.21	Reserved	0~1(0)
Pb.22	Reserved	0.0~380.0(380.0)
Pb.23	Parameters copy	0~5(0)

Parameters copy function can be realized through operation panel.

0: No operation. When upload or download completed, the parameter restores automatically to 0.

1: Upload parameters. Press **PRG** button to upload parameters to the operation panel after setting, and will display percentage of copy process when indicating "LoAd".

2: Download parameters (without motor's parameters). Press **PRG** button to download parameters to the inverter after setting, and will display percentage of copy process when indicating "LoAd". Parameters of motor (P9 Group) will not be downloaded to the inverter with this operation.

3: Download parameters (all users' parameters). Press **PRG** button to download parameters to the inverter after setting, and will prompt percentage of copy process when indicating "CoPy".

4: Parameters blocking enabled (upload not allowed). Avoiding deleting parameters that have been

copied to the operation panel if you upload data unconsciously again. After setting this function, "HoLd" will be displayed on the operation panel when conducting parameters upload if you do not carry out unblocking parameters blocking function (upload allowed).

5: Unblocking parameters blocking (upload allowed), allowing uploading parameters to the operation panel after setting.

Note:

- ◆ After completing the above settings, Pb.23 will be automatically returned to "0: no action". "E.CPY" will display if error occur during copies.
- ◆ The parameters for V5 inverter and V6 inverter cannot be copied between each other.
- ◆ The copy operation can be performed only when the operation panel copy identification codes of the two inverters for upload and download (d1.09) are consistent.
- ◆ The copy function can be completed only when the inverter is completely powered off and then powered up after the download of the parameters for copy is completed.

6.13 Communication Parameters (Group PC)

PC.00	Communication baud rate	4~8(6)
PC.01	Data format	0~2(0)
PC.02	Local address	1~247(1)

The inverter supports international Modbus RTU protocol. Refer to the appendix.A.

PC.00 determines communication baud rate ranging from 4800~57600bps.

4: 4800bps

5: 9600bps

6: 19200bps

7: 38400bps

8: 57600bps

PC.01 sets communication format, odd-even check.

0: 1-8-1 format, without check.

1: 1-8-1 format, even check.

2: 1-8-1 format, odd check.

PC.02 sets the local address. 0 is the broadcast address, available address "1~247", 248~255 for reservation.

PC.03	Reserved	0(0)
PC.04	Master-slave mode	0~2(0)
PC.05	Operation Address from master to slave (set by master)	0~2(0)
PC.06	Slave setting frequency proportional coefficient (set by slave)	0.00~10.00(1.00)

PC.04 master-slave mode:

0: SCIA is slave mode and SCIB is slave mode;

1: SCIA is master mode and SCIB is slave mode;

2: SCIA is slave mode and SCIB is master mode.

PC.05 master to slave operation address (set by master), position for writing slave function code to master setting frequency:

0: P0.05 1: P8.00 2: P8.01

The inverter provides two communication ports. SCIA is a port connecting with operation panel, and SCIB is used terminal for 485+ and 485-.

In common applications, the inverter operates under slave mode (PC.04=0) and responses to external instructions.

Master mode: To active sent data to outside, which is often applied when multi-machines operate synchronously. When selecting master mode, one unit in a group of units often is set as a master to transfer operating frequency instructions to other units. When the slave receives frequency instructions from the master, it will store these instructions at the position of function code specified by PC.05. For example, if open loop digital frequency is given, adopt P0.05 as frequency reference and set PC.05=0.

If inverter master mode is set for SCIA/SCIB and operation panel has been inserted, the operation panel will take priority of controlling, and the function of inverter as master mode will lose effect automatically. Pull out the operation panel, after 10 seconds the inverter will return back to master mode.

PC.06 slave setting frequency proportional coefficient (set by the slave):

The parameter is only valid for the slave and is used to set the slave to receive correction coefficient specified by the master.

Slave setting=PC.06 × master reference.

6.14 Vector Control 2 Parameters (Group Pd)

This group of functions is only valid for vector control 2. They are invalid for Vector control 1.

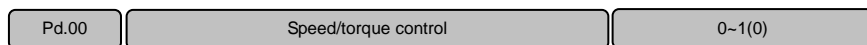

The switching between speed control and torque control can be realized through this function code.

0: Speed Control Mode

The motor action is controlled by the speed command, and the internal ASR is valid. The speed control mode shall be used together with the drive torque limiting value Pd.08 and braking torque limiting value Pd.09.

1: Torque control mode

At this time, the internal ASR is invalid, and the motor action is controlled by the analog reference torque command. When torque control mode is used, the motor speed may increase to dangerous speed because the torque command does not match the load torque. Please remember to set the speed limiting value.

Digital setting of speed limiting value: Refer to the description of forward maximum speed limiting value Pd.06 and reverse maximum speed limiting value Pd.07.

Analog setting of speed limiting value: Refer to the description of analog channel function selection.

When analog channel input is used to realize the speed limiting, function codes Pd.06 and Pd.07 are

invalid.

Note:

- ◆ Input torque reference from analog channel when operating under torque control mode. Refer to instructions of P6.21.
- ◆ The jogging command is invalid under torque control.
- ◆ Under vector control 2, it can be switched between speed control mode and torque control mode through terminal. If Pd.00 is set as 0 and the terminal function is invalid, it is under speed control. If the terminal function is valid, it switches to torque control. If Pd.00 is set as 1 and the terminal function is invalid, it is under torque control. If the terminal function is valid, it switches to speed control. Refer to the description of the terminal function of multi-functional terminals P5.00 to P5.06: "64: speed control/torque control switching".

Pd.01	Speed loop proportional gain 1 (ASR_P1)	0.000~6.000(2.00or3.00)
Pd.02	Speed loop integral time 1 (ASR_I1)	0.000~6.000 s(0.200)
Pd.03	Speed loop proportional gain 2 (ASR_P2)	0.000~6.000(2.00or3.00)
Pd.04	Speed loop integral time 2 (ASR_I2)	0.000~6.000 s(0.200s)
Pd.05	ASR switching frequency	0.00~300.00 Hz(5.00Hz)

Adjust proportional gain and integral time for the speed regulator.

Proportional gain P:

In the case of vector control 2 without encoder speed feedback, the leave-factory value of this parameter is 2.00. In the case of vector control 2 with encoder speed feedback, the leave-factory value is 3.00.

Adjust according to rotating inertia of machines connecting with motor. For machines with large rotating inertias, please increase P gain; for machines with small rotating inertias, please decrease P gain.

When P gain is greater than inertia, although the control response can be accelerated, the motor may shock or overshoot. Reversely, if P gain is smaller than inertia, the control response will get slower and the time taken to adjust the speed to the stable value will longer.

Integral time I:

The integral is invalid when setting the integral time I to 0 (controlled by P alone). To ensure the difference between the speed instructions and real speed is 0 under steady-state conditions, set the integral time I to non-0 values. When I value is smaller, the system responses quickly. But if the value is very small, shock will occur. If I value is greater, the system responds slowly.

Adjust PI settings when operating quickly or slowly:

When the motor speed is greater than ASR switching frequency Pd.05, Pd.01 and Pd.02 will act to make the system obtain reasonable dynamic response when no shock occurs. If the motor speed is smaller than ASR switching frequency Pd.05, Pd.03 and Pd.04 will act. To obtain reasonable dynamic response when operating slowly, increase proportional gain Pd.03 and reduce integral time Pd.04 properly.

Pd.06	Maximum speed limit for forward running when torque control	0.00~300.00Hz(50.00Hz)
Pd.07	Maximum speed limit for reverse running when torque control	0.00~300.00Hz(50.00Hz)

Upon torque control, the speed cannot be controlled. When the set torque is larger than the load torque, the motor speed will keep rising to the speed limiting value. This function code sets the forward/reverse maximum speed limiting value.

Note:

- ◆ The analog channel input may be used to realize the maximum speed limiting upon torque control. Refer to the description of analog channel function selection P6.21.
- ◆ When analog channel input is used to realize speed limiting, terminals can be used forcefully use Pd.06 and Pd.07 as the speed limiting value.

Pd.08	Drive torque limit	0.0~250.0 %(180.0%)
Pd.09	Braking torque limit	0.0~250.0 %(180.0%)

Pd.08 and Pd.09 are used to limit the maximum output torque of the inverter. The limit value is proportion of the rated output torque of motor. When large braking torque is required, please adopt additionally the energy braking method.

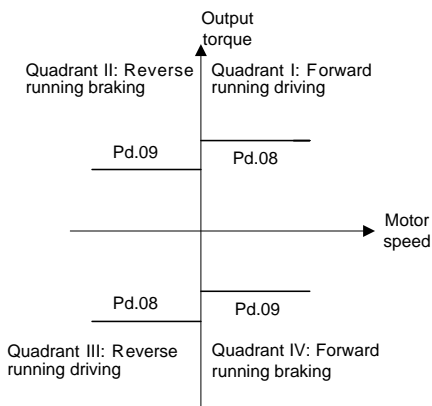

Fig. 6-38 Torque limit

Note: When setting P9.00 to 1, i.e. operating with variable torque load, the setting range of Pd.08 and Pd.09 change to 0.0~150.0%. The leave-factory value is 135.0%

Pd.10	Reserved	0~65535(4)
Pd.11	Reserved	0.000~65.535(0.010)
Pd.12	Torque acceleration time	0~120.00s(0.10s)
Pd.13	Torque deceleration time	0~120.00s(0.10s)

It sets the torque acceleration/deceleration time upon torque control. This function code is invalid upon speed control.

The time for the command torque increases from 0 to rated torque is the torque acceleration time. The time for command torque decreases from rated torque to 0 is the torque deceleration time.

Pd.14	Pre-magnetizing time	0.000~8.000 s(0.300s)
-------	----------------------	-----------------------

Pre-magnetizing is to create magnetize flux before the motor starts, aiming at fast response upon starting up of the motor. When operation instructions are available, bring the inverter into the pre-magnetizing status in the time set by this function code. After establishing the magnetize flux, try to accelerate normally. If the function code is set to 0, no pre-magnetizing process is applied.

Note: The motor may rotate during pre-magnetizing, and then adopt mechanical braking additionally.

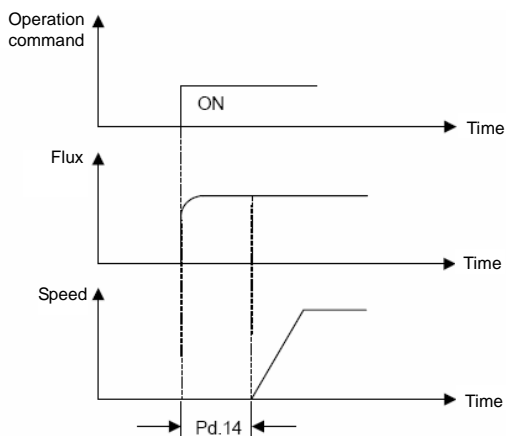

Fig. 6-39 Pre-magnetizing

Pd.15	Current loop scale coefficient (ACR_P)	0~2000(1000)
Pd.16	Current loop integral coefficient (ACR_I)	0~6000(1000)

Vector control will control the output current of motor and keep track of current instruction value. Scale and integral gain of current control (ACR) shall be set here. Usually the factory default shall not be changed. Generally, increase P gain when coil inductance is high, decrease P gain when coil inductance is low. Current oscillation will be occurred as a result of setting I gain to extremely high.

Pd.17	Vector control slip compensation gain (electric)	10.0~300.0 %(100.0%)
-------	--	-----------------------

When loads increase, motor slip will increase, but the rotating speed will decrease. The speed of motor can be controlled constantly by slip compensation. Please make adjustments according to below conditions:

When the motor speed is below the setting target value, increase vector control slip compensation gain.

When the motor speed is above the setting target value, decrease vector control slip compensation gain.

Note: When the temperature of motor increases, interior parameters of motor will change and the slip will increase. Adjusting the function code can help to compensate the effects from temperature rise of motor.

Pd.18	Vector control slip compensation gain (power generation)	10.0~300.0 % (100.0%)
-------	--	-----------------------

When loads increase, motor's slip will increase, and the rotating speed will also increase. The speed of motor can be controlled constantly by slip compensation. Please make adjustments according to below conditions:

When the motor speed is below the setting target value, decrease vector control slip compensation gain.

When the motor speed is above the setting target value, increase vector control slip compensation gain.

Note: When the temperature of motor increases, interior parameters of motor will change and the slip will increase. Adjusting the function code can help to compensate the effects from temperature rise of motor.

Pd.19	ASR input filtering time	0.0~500.0 ms (0.5ms)
-------	--------------------------	----------------------

This function defines the input filtering time of speed adjuster (ASR). In general, it needs no modification.

Pd.20	ASR output filtering time	0.0~500.0 ms (0.5ms)
-------	---------------------------	----------------------

This function defines the input filtering time of speed adjuster (ASR). In general, it needs no modification.

Pd.21	Number of pulses per turn for encoder (vector control 2 with encoder speed feedback)	1~9999 pulses/turn (1024)
-------	--	---------------------------

It is used upon vector control 2 with encoder speed feedback. The number of pulses per turn for encoder must be defined. This parameter shall be set properly according to the number of pulses per turn of the encoder.

Pd.22	Encoder direction selection	0~1 (0)
-------	-----------------------------	---------

0: Forward

1: Reverse

The leave-factory value is 0. If the wiring sequence for connecting the encoder to inverter connection board does not match the wiring sequence for connecting inverter to motor, this parameter may be set to "1" to adjust the wiring sequence to avoid re-wiring.

Pd.23	Interrupt detection time of encoder	0.0~8.0 s (2.0s)
-------	-------------------------------------	------------------

Pd.23 is used to define the interrupt detection time for encoder signal upon vector control 2 with encoder speed feedback. If the encoder interrupt time exceeds the time set in Pd.23, the inverter will report E.dL1 error.

Pd.24	Deceleration ratio between motor and encoder	0.001~65.535 (1.000)
-------	--	----------------------

If the encoder is directly mounted on the motor shaft, set this parameter to 1. If the encoder is not directly mounted on the motor shaft, there exists deceleration ratio between motor shaft and encoder.

Pd.25	Zero servo enable	0~1 (0)
-------	-------------------	---------

Set this parameter according to the actual deceleration ratio.

0: Zero servo disable

1: Zero servo enable

Note: When Pd.25 is set as 0, "zero servo valid" can be realized through function 66 of X terminal (zero servo enable terminal). For details, please refer to description of P5 group.

Pd.26	Zero servo initial frequency	0.00~10.00 Hz (0.30Hz)
Pd.27	Zero servo gain	1.000~9.999 (1.000)

Upon vector control 2 with encoder speed feedback, when the motor speed is less than the rotation speed corresponding to the zero servo initial frequency Pd.26, if the zero servo enable is valid, it enters zero servo locking status. At this time, the position of the motor in stop status will be maintained. The zero servo initial frequency is the condition for the inverter to enter zero servo status. If Pd.26 is too large, it may cause over-current failure. If adjustment is needed, you may increase/decrease the leave-factory value. Zero servo gain Pd.27 is the parameter to adjust the zero servo retentivity. When this value is increased, the zero servo rapidity can be increased. However, if it is too large, it may cause vibration of the inverter.

Note: For the zero servo function enabled by function code Pd.25, you may exit from the zero servo mode by setting the frequency higher than the zero servo initial frequency. For the zero servo function enabled by function 66 of X terminal (zero servo enable terminal), when the terminal is invalid, it exits from the zero servo mode. It doesn't matter whether the setting frequency is higher than the zero servo initial frequency Pd.26 or not.

Pd.28	Static friction compensation coefficient	0.0~100.0% (0.0%)
-------	--	-------------------

When the system is under torque control mode, to overcome the static friction force upon zero-speed operation or startup of the system, static friction compensation coefficient may be set to provide preset torque increase for the system.

Pd.29	Sliding friction compensation coefficient	0.0~100.0% (0.0%)
-------	---	-------------------

When the system is under torque control mode, the friction force existing during the system operation will reduce the inverter output torque. Sliding friction compensation coefficient may be set to reduce the influence of the friction on the inverter output torque.

Pd.30	Rotation inertia compensation coefficient	0.0~100.0% (0.0%)
Pd.31	Rotation inertia compensation frequency upper limit 1	0.00~300.00 Hz (0.00Hz)
Pd.32	Rotation inertia compensation frequency upper limit 2	0.00~300.00 Hz (50.00Hz)

When the system is under torque control mode, if the system load inertia is large, additional rotation inertia compensation shall be provided during the acceleration/deceleration of the system. The compensation determined by the rotation inertia compensation coefficient Pd.30 is valid only when it is less than Pd.31 which corresponds to the rotation inertia compensation frequency upper limit 1.

Note: It shall be ensured that the normal and stable running frequency of the inverter is above the rotation inertia compensation frequency upper limit 1. Pd.32, the rotation inertia compensation frequency upper limit 2, is generally set as the maximum frequency of the inverter.

Pd.33	Torque limiting compensation coefficient of constant power zone	0.0~100.0% (40.0%)
-------	---	--------------------

This parameter compensates the torque limiting of the constant power zone. The acceleration/deceleration time and output torque of the inverter when running in constant power zone can be optimized by changing this parameter.

Pd.34	Reserved	0~65535 (28)
Pd.35	Reserved	0~65535 (1500)
Pd.36	Torque taper	0~65535 (0)

When the system is in torque control mode, the inertial the final output torque of the inverter can be optimized by adjusting parameter Pd.36.

6.15 Failure Record Parameters (Group d0)

d0.00	Fault type record 2	0~62(0)
d0.01	Fault type record 1	0~62(0)
d0.02	(Latest) Fault type record 0	0~62(0)
d0.03	Bus voltage of the latest failure	0~999 V(0V)
d0.04	Actual current of the latest failure	0.0~999.9 A(0.0A)
d0.05	Operation frequency of the latest failure	0.00~300.00 Hz (0.00Hz)

The inverter can record the latest three fault' code serial number (see 7.1 list of failure and alarm information) and bus voltage, output current and operation frequency during failures recently occurred for the ease of Trouble Shooting and repair.

Note: Upon the under-voltage display (LU), the parameters of fault type and failure time will not be saved.

d0.06	Total power-up time of inverter	0.000~65.535 kh(0.000kh)
d0.07	Total operation time of inverter	0.000~65.535 kh(0.000kh)
d0.08	Record of maximum temperature of heatsink	0.0~100.0 °C(0.0° C)
d0.09	Record of maximum bus voltage fluctuation	0~1000V(0V)
d0.10	Reserved	0.00~300.00Hz(0.00Hz)
d0.11	Reserved	0~5(0)

The inverter can record automatically the following information: Total power-up time of inverter, total operation time of inverter, record of maximum temperature of heat-sink, record of maximum bus voltage fluctuation,.

6.16 Product Identity Parameters (Group d1)

d1.00	Serial number	0.0~FFF.F(Factory)
d1.01	Software version number of control panel	0.00~99.99(Factory)
d1.02	Non-standard version number of software of control panel	0.00~FF.FF(Factory)
d1.03	Software version number of operating panel	0.000~F.FFF(Factory)
d1.04	Software version number of extended panel	0.000~F.FFF(Factory)
d1.05	Manufacturer's bar code 1	0~9999(Factory)
d1.06	Manufacturer's bar code 2	0~9999(Factory)
d1.07	Manufacturer's bar code 3	0~9999(Factory)
d1.08	Manufacturer's bar code 4	0~9999(Factory)
d1.09	Operation panel copy identification code	0.00~655.35(Factory)
d1.10	Control board software identification cod	0~65535(Factory)
d1.11	Reserved	0~65535(Factory)

Software version number and non-standard version number of product represent the software type. Each inverter has a unique bar code for identification of product and determining product information.

6.17 Use of Display Parameters (Group d2)

d2.00	Temperature of heatsink	0.0~100.0° C (0.0° C)
d2.01	Terminal count value	0~65535(0)
d2.02	AI1 percentage after curvilinear transformation	0.0~100.0%(0.0%)
d2.03	AI2 percentage after curvilinear transformation	0.0~100.0%(0.0%)
d2.04	AI3 percentage after curvilinear transformation	0.0~100.0%(0.0%)
d2.05	DI percentage after curvilinear transformation	0.0~100.0%(0.0%)
d2.06	Operation panel \wedge/\vee digital adjustment volume	0~65535(0)
d2.07	Terminal UP/DN digital adjustment volume	0~65535(0)
d2.08	Reserved	0.00~65535(Factory)
d2.09	Input status display of X terminal	0~FFFF(0000)
d2.10	Reference voltage 1 (percentage)	0.0~100.0%(Factory)
d2.11	Reference voltage 2 (percentage)	0~9999(Factory)
d2.12	AI failure source display	0~5(Factory)
d2.13	Current detection failure source display	0~6(Factory)
d2.14	Frequency corresponding to the current rotation speed of the motor	0.00~655.35Hz(0.00Hz)

Parameters in d2 group are read only parameters.

d2.09 indicates the input status of X terminal. 0 indicates Open, while 1 indicates Close. Hexadecimal combination is adopted, and the lowest bit indicates X1.

d2.12 indicates the failure source of analog input. 1 indicates AI1 exceeding limit, 2 indicates AI2 exceeding limit, 3 indicates AI3 exceeding limit, 4 indicates AV4/AI4 exceeding limit, and 5 indicates AV5/AI5 exceeding limit. Among them 4 and 5 only valid when use EX-PM01.

d2.13 indicates the current detection failure source display. 2 indicates phase W abnormal, 4 indicates phase V abnormal, and 6 indicates phase U abnormal.

d2.14 indicates the frequency corresponding to the actual motor rotation speed under vector control 2 with encoder speed feedback.

d2.15~d2.24	Reserved	0~65535(Factory)
-------------	----------	------------------

6.18 User-defined Function Code Displayed/hidden Zone Parameters (Group A0)

A0.00	Password of displayed/hidden zone of user-defined function code	0~FFFF(Factory)
A0.01	Displayed/hidden function 1 of user-defined function code	0~FFFF(FFFF)
A0.02	Displayed/hidden function 2 of user-defined function code	0~FFFF(FFFF)

Customize function code menu by function code of group A0. Protect the customized menu with password A0.00. Only function code groups with corresponding Bit set as 1 by A0.01 or A0.02 can be shown.

Note:

- ◆ Factory default for password of displayed/hidden zone of user-defined function code is 1. LSB (the least significant bit) to MSB (the most significant bit) of A0.01 correspond to P0, P1, P2, P3, P4, P5, P6, P7, P8, P9, PA, Pb, PC, Pd, PE and d0 in turn. LSB to MSB of A0.02 correspond to d1, d2 and reserved 14 bits in total.
- ◆ Zones of PE, C, U0 and U1 are reserved for parameters by manufacturer.
- ◆ When recovery practices of function code P0.01=4 or 5, the displayed/hidden function can be reset back to factory default.

Chapter 7 Fault Diagnosis

7.1 List of Fault and Alarm Information

V6-H serial inverter is equipped with complete protection functions to provide efficient protection while utilizing its performance sufficiently. Some failure instructions may be displayed during operation. Compare the instructions with the following table and analyze, decide the causes and solve failures. For damages on units or questions that can't be resolved, please contact with local distributors/agents, service centers or manufacturer for solutions.

Failure No.	Failure code	Failure description	Potential causes	Solutions
1	E.oc1	Over current protection when acceleration operation	Low grid voltage	Check input power supply
			Startup too fast during motor operation	Restart after the motor stops rotating
			Rotating inertial of load is very large and shock load is very heavy	Increase the acceleration time and reduce the occurrences of sudden change of load
			Improper setting of motor parameters	Set motor parameters properly
			Set start-up frequency too high	Decrease start-up frequency
			Acceleration time is too short	Lengthen acceleration time
			Set V/F curve ratio too large	Adjust V/F curve setting and torque boost
2	E.oc2	Over current protection when deceleration operation	Power level of inverter is small	Replace with inverter with proper model
			Low grid voltage	Check input power supply
			Rotating inertial of load is too large	Choose appropriate energy braking components
			Improper setting of motor parameters	Set motor parameters properly
			Deceleration time is too short	Lengthen deceleration time
3	E.oc3	Over current protection when operation with constant speed	Power level of inverter is small	Replace to inverter with proper model
			Sudden change of load during operation	Decrease load's abrupt frequency change and amplitude
			Improper setting of motor parameters	Set motor parameters properly
4	E.ov1	Over voltage protection when acceleration operation	Motor short to ground	Check motor wiring
			Abnormal input power supply voltage	Check input power supply
			Fast start-up again when motor operates with high speed	Start again after the motor stop rotating
5	E.ov2	Over voltage protection when deceleration operation	Motor short to ground	Check motor wiring
			Rotating inertial of load is too large	Choose appropriate energy braking components
			Deceleration time is too short	Lengthen deceleration time

Failure No.	Failure code	Failure description	Potential causes	Solutions
6	E.oV3	Over voltage protection when operation with constant speed	Motor short to ground	Check motor wiring
			Abnormal input power supply	Check input power supply
			Rotating inertial of load is too large	Choose appropriate energy braking components
7	E.PCU	Interference protection	Severely Interfered by exterior signal	Ask professional technicians to maintain
8	E.rEF	Abnormal comparison benchmark	Loose connection of connectors inside the inverter	Ask professional technicians to maintain
			Abnormal internal switching power supply	Seek for technical support
			Abnormal signal sampling and comparison circuit	Seek for technical support
9	E.AUt	Auto-tuning failure	Enable auto-tuning function during motor spinning	Perform auto-tuning after the motor stops to rotate
			Auto-tuning overtime	Check whether motor wirings are well connected Length of motor wiring within 100m
			Incorrect setting of motor parameters in group P9	Please reset the parameters according to the nameplate parameters on the motor.
10	E.FAL	Module protection	Output over current	Check whether the motor the output connection are short circuited, whether the ground is short circuited and whether the load is too heavy.
			DC terminal overvoltage	Check the mains power supply and whether the large inertia load has no function of quick stop at energy consumption brake.
			Loose connection of connectors inside the inverter	Ask professional technicians to maintain
11	E.oH1	Heatsink 1 over temperature protection	Ambient over-temperature	Lower the ambient temperature and strengthen ventilation and radiation.
			Blockage of air duct	Clean the dusts, wools and other foreign objects in the air duct.
			Fan failure	Check whether fan wirings are well connected. Replace a new fan of the same model.
			Inverter module failure	Seek for technical support
			Temperature detection circuit failure	Seek for technical support
12	E.oH2	Heatsink 2 over temperature protection	Ambient over-temperature	Lower the ambient temperature and strengthen ventilation and radiation
			Blockage of air duct	Clean the dusts, wools and other foreign objects in the air duct

Failure No.	Failure code	Failure description	Potential causes	Solutions
			Fan failure	Check whether fan wirings are well connected. Replace a new fan of the same model
			Rectifier module failure	Seek for technical support
			Temperature detection circuit failure	Seek for technical support
13	E.oL1	Inverter overload protection	Input power under voltage	Check input power supply
			Fast start-up when motor operates with high speed	Start again after the motor stop rotating
			Keep overloading for a long period of time	Shorten the overloading time and reduce load
			Acceleration and deceleration time is too short	Prolong the acceleration/deceleration time
			V/F curve ratio is set too large	Adjust V/F curve setting and torque boost
			Power level of inverter is small	Replace to inverter with proper model
14	E.oL2	Motor overload protection	Input power under voltage	Check input power supply
			Motor rotation is blocked or load mutation occurs	Prevent the motor rotation from blocking and reduce the load mutation
			Common motor maintains running under heavy load for a long period of time	Replace the common motor with variable frequency motor or improve the running frequency
			Motor overload protection time is set too small	Increase the motor overload protection time
			V/F curve ratio is set too large	Adjust V/F curve setting and torque increment
			DC braking current is set too high	Reduce the DC brake current
15	E.oUt	Peripheral protection	External failure terminal enable	Check the external failure terminal status
			Stall over voltage or over current and the time lasts for more than one minute	Check whether the external load is normal
19	E.CUr	Current detection fault	Current detection circuit failure	Seek for technical support
20	E.GdF	Output to ground short circuit	Wrong connection	Correct the connection error as per the user's manual
			Motor failure	Replace the motor after performing ground insulation test
			Invert module failure	Seek for technical support
21	E.LV1	Abnormal power failure during running	Ground leakage current at the output side of the inverter is too high	Seek for technical support
			Mains power fluctuation or momentary power failure	Check the local mains power
22	E.ILF	Input power failure	There is abnormal connection, missing connection or disconnection at the power terminal of the inverter	Check the power connections as per the operational regulations and eliminate the errors of missing connection and disconnection

Failure No.	Failure code	Failure description	Potential causes	Solutions
			Serious unbalance of input power at three phases	Check whether the unbalance of input power at three phases comply with the requirements
			Burning of capacitor of the inverter	Seek for technical support
			The power-on buffer circuit of the inverter is faulty	Seek for technical support
23	E.oLF	Abnormal output phase loss	There is abnormal connection, missing connection or disconnection at the output side of the inverter	Check the power connections at the output side of the inverter as per the operational regulations and eliminate the errors of missing connection and disconnection
			Unbalance of output three phases	Check whether motor is kept well Shut down the power supply to check whether the terminal characteristics both at the output side and DC side of the inverter are consistent
24	E.EEP	EEPROM failure	EEPROM reading and writing failure	Seek for technical support
25	E.dL3	Relay contact failure	Loose connection of connectors inside the inverter	Ask professional technicians to maintain
			The power-on buffer circuit is faulty	Seek for technical support
26	E.dL2	Temperature sampling disconnection	Ambient under temperature	Check whether the ambient temperature complies with the requirements
			The temperature sampling circuit inside the inverter is faulty	Seek for technical support
27	E.dL1	Encoder cable disconnection	Encoder connection is incorrect	Change the encoder cable connection
			Encoder has no signal output	Check whether the encoder and power supply are normal.
			Encoder cable disconnection	Reconnect
			Abnormal function code setting	Confirm that the relevant function codes of the encoder are set properly
28	E.P10	+10V power output abnormal	+10V power overload	Increase +10V power load impedance Utilize externally independent power supply
			+10V power supply and GND is short circuited	Eliminate the short circuit failure
			+10V power terminal circuit failure	Seek for technical support
29	E.AIF	Analog input abnormal	Analog input voltage is too high	Check whether the analog input voltage complies with the requirements
			Analog input circuit failure	Seek for technical support

Failure No.	Failure code	Failure description	Potential causes	Solutions
			Analog input circuit signal interfered	Increase the P6.22~P6.24 AI filtering time
30	E.Ptc	Motor over temperature(PTC)	The motor temperature signal reaches the alarm setting value	Strengthen ventilation and radiation
			Thermistor resistance failure	Check the thermistor
			The sensor protection threshold of the motor is set improperly	Adjust the sensor protection threshold of the motor
31	E.SE1	Communication abnormal 1 (Operation panel 485)	The communication of operation panel 485 is disconnected	Check the connection of the equipment communications
			The communication of operation panel 485 is faulty	Check whether the data receiving and transmission complies with the protocol, whether the check sum is correct and whether the receiving and transmission interval complies with the requirements
			The inverter is set to master mode	Set the inverter to slave mode
32	E.SE2	Communication abnormal 2 (Terminal 485)	The communication of terminal 485 is disconnected	Check the connection of the equipment communications
			The baud rate is set improperly	Set compatible baud rate
			The communication of terminal 485 is faulty	Check whether the data receiving and transmission complies with the protocol, whether the check sum is correct and whether the receiving and transmission interval complies with the requirements
			The communication of terminal 485 is time-out	Check whether the communication timeout is set properly and confirm the communication cycle of the application program
			The failure alarm parameter is set improperly	Adjust the failure alarm parameter
			The inverter is set to master mode	Set the inverter to slave mode
33	E.VEr	Version compatibility abnormal	The software version of the operation panel is incompatible	Seek for technical support
34	E.CPy	Copy failure	The data error appears when copying the inverter parameters to the operation panel	Check the connections of the operation panel

Failure No.	Failure code	Failure description	Potential causes	Solutions
			The data error appears when copying the parameters from the operation panel to the inverter	Check the connections of the operation panel
			The parameters are directly downloaded without undergoing copy and upload operations.	Perform download before uploading the parameters
			Control board software version incompatible	Check if d1.09 is consistent
36	E.dL4	Expansion card connection abnormal	Expansion card connection is loosened	Ask professional technicians to maintain
			Expansion card failure	Seek for technical support
37	E.loF	Terminal mutual exclusion check failed	The functions of X1 to X7, A11, A12 and DI terminals are set in a repeated manner	Modify the settings of X1 to X7, A11, A12 and DI terminals and ensure the setting functions are not repeated (excluding null function)
38	E.oL3	Hardware overload protection	Load failure	Check whether motor is blocked Replace inverter with proper model
			Input failure	Check whether there is phase loss
			Output failure	Check whether there are phase loss or short circuit
63	-LU-	Power under voltage	The power voltage is lower than the minimum operating voltage of the equipment	Check input power supply
			Abnormal internal switching power supply	Seek for technical support

7.2 Troubleshooting Procedures

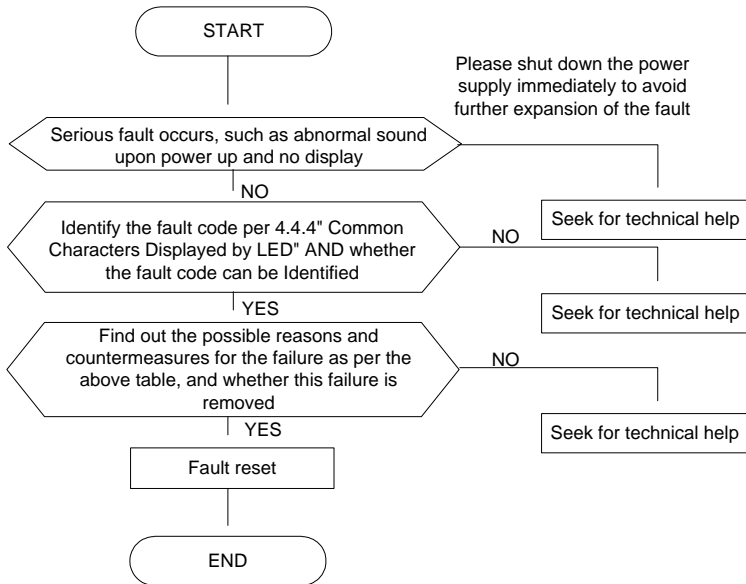

Chapter 8 Routine Repair and Maintenance

The application environment (such as temperature, humidity, dust and powder, wool, smoke and oscillation), burning and wearing of internal devices and other factors may increase the possibilities of inverter failure. To reduce the failures and prolong the service life the inverter, it needs to conduct routine repair and periodic maintenance.



Note

1. Only the personnel receiving professional training can dismantle and replace the inverter components.
2. Prior to inspection and maintenance, please make sure that the power supply to the inverter has been shut down for at least ten minutes or the CHARGER indicator is OFF, or there may be risks of electric shock (the inverter with power level of V6-H-4T11G/15L or above has CHARGER indicator).
3. Do not leave metal components and parts in the inverter, or it may damage the equipment.

8.1 Routine Maintenance

The inverter shall be used under the allowable conditions as recommended in this manual and its routine maintenance shall be conducted as per the table below.

Item	Inspection Contents	Inspection Means	Criteria
Operating Environment	Temperature	Thermometer	-10 ~ +40°C Derated at 40 to 50°C, and the rated output current shall be decreased by 1% for every temperature rise of 1°C.
	Humidity	Humidimeter	5 ~ 95%, no condensing
	Dust, oil, water and drop	Visual check	There are no dust, oil, water and drop.
	Vibration	Special test instrument	3.5mm, 2~ 9Hz; 10m/s ² , 9~ 200Hz; 15m/s ² , 200~ 500Hz
	Gas	Special test instrument, smell check and visual check	There are no abnormal smell and smoke.
Inverter	Overheat	Special test instrument	Exhaust normal
	Sound	Listen	There is no abnormal sound.
	Gas	Smell and visual check	There are no abnormal smell and smoke.
	Physical appearance	Visual check	The physical appearance is kept intact.
	Heatsink fan ventilation	Visual check	There are no fouling and wool that block the air duct.
	Input current	Amperemeter	In the allowable operating range. Refer to the nameplate.
	Input voltage	Voltmeter	In the allowable operating range. Refer to the nameplate.
	Output current	Amperemeter	In the rated value range. It can be overloaded for a short while.
	Output voltage	Voltmeter	In the rated value range.
Motor	Overheat	Special test instrument and smell.	There are no overheat fault and burning smell.
	Sound	Listen	There is no abnormal sound.
	Vibration	Special test instrument	There is no abnormal oscillation.

8.2 Periodic Maintenance

It needs to perform periodic inspection on the inverter once every three to six months according to the application environment and work conditions.

Item	Inspection Contents	Inspection Means	Criteria
Inverter	Main circuit terminal	Screwdriver/sleeve	The screws are tightened and the cables are kept well.
	PE terminal	Screwdriver/sleeve	The screws are tightened and the cables are kept well.
	Control circuit terminal	Screwdriver	The screws are tightened and the cables are kept well.
	Reliability of internal connections and connectors	Screwdriver and hands	Connection is firm and reliable.
	Expansion card connector	Screwdriver and hands	Connection is firm and reliable.
	Mounting screws	Screwdriver/sleeve	The screws are tightened.
	Cleaning the dusts and powders	Cleaner	There are no dusts and wools.
	Internal foreign objects	Visual check	There are no foreign objects.
Motor	Insulation test	500VDC megameter	Normal

8.3 Component Replacement

Different types of components have different service lives. The service lives of the components are subject to the environment and application conditions. Better working environment may prolong the service lives of the components. The cooling fan and electrolytic capacitor are vulnerable components and shall be conducted routine inspection as per the table below. If any fault occurs, please conduct immediate replacement.

Vulnerable Components	Damage Causes	Solutions	Items for Routine Inspection
Fan	Bearing wear, blade aging	Change	The fan blade has no cracks and rotates normally. The screws are tightened.
Electrolytic capacitor	Ambient temperature is relatively high and electrolyte volatilizes.	Change	There are no electrolyte leakage, color change, crack and shell inflation. The safety valve is normal. Static capacity is equal to or higher than the initial value times 0.85.

Note

When the inverter is stored for a long period of time, power connection test shall be conducted once within two years and last at least five hours. It can use voltage regulator to gradually increase the value to the rated value when power connection is performed.

8.4 Insulation Test

Since the inverter has undergone insulation test upon its ex-factory, the user shall not perform such test

as much as possible under general condition. If the test is unavoidable, please perform the test strictly according to the following procedures, or it may damage the inverter.

It shall perform dielectric test strictly, or it may damage the inverter. If the dielectric test is unavoidable, please contact our company.

■ Main Circuit Insulation Test

- ◆ Utilize 500VDC megameter to perform test under condition of main power shutdown;
- ◆ Disconnect all the control board circuits to prevent the control circuits from connecting with the test voltage. For the inverter with power level of V6-H-4T11G/15L and V6-H-4T15G/18.5L, it must disconnect the terminal J1 on the drive board and the PE. For the inverter with power level of V6-H-4T18.5G/22L or above, it must disconnect three pieces of cables entry to the surge absorption circuit. Pack the disconnected cable heads with insulating tapes properly;
- ◆ The main circuit terminal shall be connected with public conducting wires:

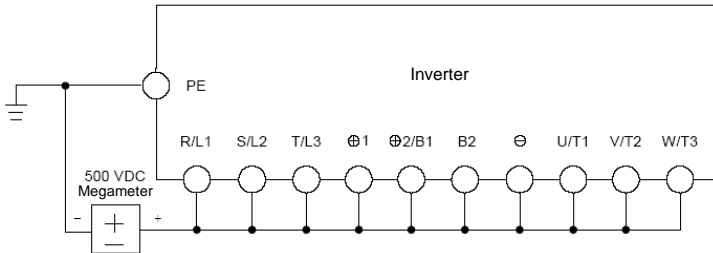

Fig.8-1 Main Circuit Insulation Test for V6-H-2T0.4G to V6-H-2T12.2G and V6-H-4T0.75G/1.5L to V6-H-4T15G/18.5L

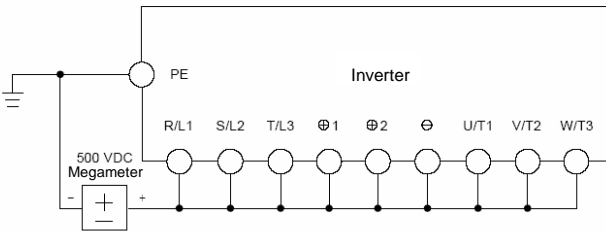

Fig.8-2 Main Circuit Insulation Test for V6-H-4T18.5G/22L to V6-H-4T500G/560L

- ◆ Megameter voltage can only be imposed between the public conducting wire of the main circuit and the PE terminal;
- ◆ The normal indication value of the megameter is 200M Ω or above.

Appendix A Modbus Communication Protocol

1. Support Protocol

Support Modbus protocol, RTU format, Broadcast address 0, slave address “1–247”, “248–255” for reservation.

2. Interface mode

RS485: Asynchronous, half duplex, LSB sending priority. Low byte is after the high byte.

Inverter communication port A (RJ45) default data format: 8–N–1, 38400 bps

Inverter communication port B (terminal RS485+/-) default data format: 8–N–1,19200 bps, see PC function code specification.

It is recommended to adopt EIA/TIA T568B, the lead of port A is defined as:

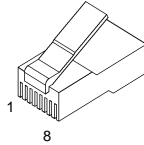

Attached Fig. 1 RJ45 interface

Lead of communication port A	1	2	3	4	5	6	7	8
Signal of communication port A	+5V	GND	485+	485-	485+	485-	GND	+5V
EIA/TIA T568A	White green	Green	White orange	Blue	White blue	Orange	White brown	Brown
EIA/TIA T568B	White orange	Orange	White green	Blue	White blue	Green	White brown	Brown

3. Protocol Format

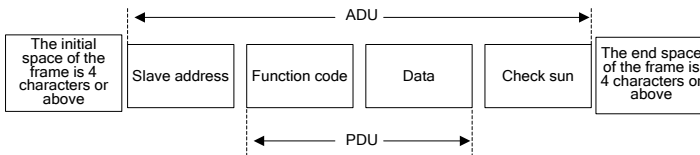

Attached Fig.2 Protocol Format

ADU (Application Data Unit) check is the CRC16 check of the first three parts of ADU and obtained through exchange of high/low bytes.

If the operation request is rejected, the feedback of PDU(Protocol Data Unit) will be error code or

abnormal code. Error code equals to function code +0x80, abnormal code shows the error cause in detail.

Examples for abnormal codes:

Abnormal code	Definition	Abnormal code	Definition
0x01	Illegal function code	0x20	Frame error: frame length error, check error
0x02	Illegal data address	0x21	Parameters are unchangeable.
0x03	Illegal data, data beyond upper/lower limits	0x22	Unchangeable upon operation of parameters
0x04	Slave operation failure, the data is within the range of upper/lower limits, but it is invalid.	0x23	Password protected for parameters
0x05	Order valid, in process, mainly occurs upon storing data into EEPROM	0x24	Non- host computer equipment control, invalid host computer command
0x06	Slave busy, mainly occurs upon storing data into EEPROM		

4. Function Interpretation

◆ Function 0x03 reads parameters and status words of multiple function code parameters of the inverter.

PDU Part Contents	Data Length (Byte)	Range
Request:		
Function code	1	0x03
Initial address of register	2	0x0000 ~ 0xFFFF
Number of registers	2	0x0001 ~ 0x0010
Response:		
Function code	1	0x03
Read bytes	1	2*Number of registers
Read contents	2*Number of registers	

◆ Function 0x06(0x41) rewrites single function code or control parameter of the inverter and save it upon power failure (not save).

PDU Part Contents	Data Length (Byte)	Range
Request:		
Function code	1	0x06(0x41)
Register address	2	0x0000 ~ 0xFFFF
Register data	2	0x0000 ~ 0xFFFF
Response:		
Function code	1	0x06(0x41)
Register address	2	0x0000~ 0xFFFF

Register data	2	0x0000 – 0xFFFF
---------------	---	-----------------

☞ **Note:** if change function code frequently, such as change setting frequency repeat, suggest use 0x41 command is better than 0x16, prevent from damage inner EEPROM.

- ◆ Function 0x10(0x42) rewrites multiple function codes or control parameters of the inverter and save them upon power failure (not save).

PDU Part Contents	Data Length (Byte)	Range
Request:		
Function code	1	0x10(0x42)
Initial address of register	2	0x0000–0xFFFF
Number of register	2	0x0001–0x0010
Bytes of register contents	1	2*Number of operating registers
Register contents	2*Number of operating registers	
Response:		
Function code	1	0x10(0x42)
Initial address of register	2	0x0000–0xFFFF
Number of register	2	0x0001–0x00100

☞ **Note:**

- 1、In case continuous storage is required, the inverter will store function codes in the register at the address from the lowest to highest, with maximum of 16 function codes being stored at the same time.
- 2、If change function code frequently, such as change setting frequency repeat, suggest use 0x42 command is better than 0x10, prevent from damage inner EEPROM.
- 3、The life of EEPROM is about 100000 times,if change setting frequency frequently, several days or several weeks may damage EEPROM, adopt write RAM, it can avoid to damage EEPROM.

- ◆ Function 0x17 reads and writes multiple function codes or control parameters of the inverter.

PDU Part Contents	Data Length (Byte)	Range
Request (Response):		
Function code	1	0x17
The initial address of reading register	2	0x0000–0xFFFF
The number of reading register	2	0x01– 0x10
The initial address of writing register	2	0x0000–0xFFFF
The number of writing register	2	0x01–0x10
The number of bytes in the writing register	1	2*Number of operating registers
The writing register contents	2*Number of operating registers	
Response:		
Function code	1	0x17

PDU Part Contents	Data Length (Byte)	Range
Read the number of bytes in the register	1	0x02~0x20
Read data contents	2*Read bytes	0x0000~0xFFFF

Operating sequence: Read firstly and rewrite secondly, but the register 0xF080 is an exception, which shall be written firstly and read secondly so as to facilitate the management of the operation panel.

5. Inverter Register Address Distribution

Attached Table-1

Address Space	Meaning
0x0000 ~ 0x1A00	The corresponding relationship between the function codes of the inverter and the Modbus protocol register address. The bytes at higher orders refer to function code groupnumber. The bytes at lower orders refer to groupnumber, express with HEX adecimal. P0 to PE, d0, d1, d2, H0、 H1、 H2、 A0、 C0、 U0、 U1 corresponds to the bytes at higher orders such as 0x00 to 0x0E, 0x0F, 0x10, 0x11, 0x12、 0x13、 0x14、 0x15、 0x16、 0x17、 0x18. for example,the Modbus address of function code Pb.23 is $(0x0b < 8) + 23 = 0x0b17$
0x4000 ~ 0x5A00	The corresponding relationship between the function code attribute word of the inverter and the Modbus protocol register address. The bytes at higher orders refer to the function code group No. plus 0x40, while the bytes at lower orders refer to serial No. in the group, for example, 0x4b17 corresponds to the attribute word of the function code Pb.23. The attribute words are defined in the following order: Bit0 ~ Bit2 for unit, Bit3 ~ Bit4 for modifying attribute, Bit5 ~ Bit6 for precision and Bit7 ~ Bit15 for reserved purpose.
0x8000 ~ 0x800D	The register for control word of the inverter. Refer to Attached Table 2 for details.
0x810B ~ 0x8193	The register for status word of the inverter. Refer to Attached Table 3 for details.
0xF000 ~ 0xF002	Special register for input password authentication. Refer to Attached Table 4 for details.
0xF080~ 0xF084	Read the current value, upper limit, lower limit, and factory default value of the function code, and rewrite the function code. Refer to Attached Table 5for details.

◆ Register for control word of the inverter.

Attached Table-2

Register address	Name of Parameters	Register address	Name of Parameters
0x8000	Control command word	0x8007	AO2 output host computer percentage
0x8001	Open loop digital frequency reference	0x8008	Y2 output host computer percentage
0x8002	Running command reference mode	0x8009	Slave setting frequency scale coefficient
0x8003	Open loop main reference mode	0x800A	Virtual terminal
0x8004	Close loop digital voltage reference	0x800B	Y1 terminal output function
0x8005	Close loop digital rotation velocity reference	0x800C	Acceleration time 0
0x8006	AO1 output host computer percentage	0x800D	Deceleration time 0
Note: The virtual terminals from LSB to MSB are X1, X2, X3, X4, X5, X6, X7, A11, A12, A13, Y1, Y2 and relay, bit13 ~ bit15 are reserved.			

◆ Register for status word of the inverter.

Attached Table-3

Register	Name of Parameters	Precision	Register	Name of Parameters	Precision
0x810B	Equipment status word 1		0x8114	Display parameters of stopping status	According to currently stopping display
0x810E	Equipment status word 4		0x8116	Display parameters of running status	According to currently running display
0x8120	Reference frequency (Hz)	0.01Hz	0x8180	Reference frequency (Hz)	0.01Hz
0x8122	Bus voltage(V)	1V	0x8182	Bus voltage(V)	1V
0x8124	AI1 (V)	0.01V	0x8184	AI1 (V)	0.01V
0x8126	AI2 (V)	0.01V	0x8186	AI2 (V)	0.01V
0x8128	AI3 (V)	0.01V	0x8188	AI3 (V)	0.01V
0x812A	DI (%)	0.1%	0x818A	DI (%)	0.1%
0x812C	External counts	1	0x818C	External counts	1
0x812E	Rotate speed of motor	1	0x818E	Rotate speed of motor	1
0x8130	Close loop reference (%)	0.1%	0x8190	Close loop reference (%)	0.1%
0x8132	Close loop feedback (%)	0.1%	0x8192	Close loop feedback (%)	0.1%
0x8134	Reference torque(%)	0.1%	0x8194	Reference torque (%)	0.1%
0x8136	Operating frequency (Hz)	0.01Hz	0x8196	Reserved	
0x8138	Output current(A)	0.1A or 0.01A	0x8198	Reserved	
0x813A	Output torque(%)	0.1%	0x819A	Reserved	
0x813C	Output power (kW)	0.1kW	0x819C	Reserved	
0x813E	Output voltage(V)	1V	0x819E	Reserved	

Note: 0x8121~0x819Fodd numbers are display attribute word, from LSB to MSB are Hex/Dec for 1bit, precision for 2bit, modification for 2bit and unit for 3Bit.

The register addresses 0x8120 ~0x813F refer to the display parameters corresponding to P2.02, while the register addresses 0x8180 ~0x8193 refer to the display parameters corresponding to P2.03.

The inverter of 3.7kw and below,the output current display precision is 0.01A, 5.5kw and above output current display precision is 0.1A,

The bits for the control command word (0x8000) of the inverter are defined as follows:

Bit	Meaning		Bit	Meaning	
0	0: Stop command enable	1: Running command enable	3	0: Jog command disable	1: Jog command enable
1	0: Forward rotation	1: Reverse rotation	14	0: Emergency stop disable	1: Emergency stop enable
2	0: Reset command disable	1: Reset command enable	15	0: Coast to stop disable	1: Coast to stop enable

Note: Bits 4 ~ 13 are reserved.

The bits for the status word1 (0x810B) of the inverter are defined as follows:

Bit	Meaning		Bit	Meaning	
0	0: Inverter stop	1: Inverter running	5-6	Running command reference mode selection: 0: Operation panel reference, 1: Terminal reference, 2: host computer reference.	
3	0: Forward rotation	1: Reverse rotation			
4	0: Button unlocked	1: Button locked	8 to 15	0: Normal; others: Failure code	

Note: Bits 1, 2 and 7 are reserved.

The bits for the status word 4(0x810E) of the inverter are defined as follows:

Bit	Meaning		Bit	Meaning	
0	0: Non-jog running	1: Jog running	5	0: Non-open loop multi-section voltage operation	1: Open loop multi-section voltage operation
1	0: Non-close loop operation	1: Close loop operation	6	0: Normal voltage	1: Under voltage
2	0: Non-open loop multi-section frequency operation	1: open loop multi-section frequency operation	7	0: Non-single phase pulse input close loop operation	1: Single phase pulse input close loop operation
3	0: Non-close loop multi-section frequency operation	1: Close loop multi-section frequency operation	14	0: Speed control	1: Reserved
4	0: Non-common operation	1: Common operation	15	0: Vector control 1	1: Vector control 2

Note: Bits 8 ~ 13 are reserved.

◆ Special register for input password authentication

Attached Table-4

Sub function code of PDU	Meaning
0xF000	Inverter user password P0.00 authentication, and it will be closed automatically if no operation is performed within five minutes.
0xF001	PE.00 password authentication for the display and hidden areas of the specially authenticated function codes of the inverter, and it will be closed automatically if no operation is performed within five minutes.

0xF002	A0.00 password authentication for the display and hidden attributes customized areas of the function codes of the inverter, and it will be closed automatically if no operation is performed within five minutes.
--------	---

◆ Register for function code characteristics of the inverter

Attached Table-5

Register address	Meaning	Range	Read (R) and Write (W)
0xF080	Relative address of the function code	See Attached Table-1	R/W
0xF081	Current value	0 ~ 65535	R/W
0xF082	Upper Limit	0 ~ 65535	R
0xF083	Lower Limit	0 ~ 65535	R
0xF084	Factory default value of the function code	0 ~ 65535	R

It can write the function code No. into 0xF080 by reading and writing multiple register commands 0x17 firstly and then read several attributes of this function code.

6. CRC16 Function

```
unsigned int crc16(unsigned char *data, unsigned char length)
```

```
{
    int i, crc_result=0xffff;
    while(length-->0)
    {
        crc_result ^= *data++;
        for(i=0; i<8; i++)
        {
            if(crc_result & 0x01)
                crc_result = (crc_result >> 1) ^ 0xa001;
            else
                crc_result = crc_result >> 1;
        }
    }
    return (crc_result == ((crc_result & 0xff) << 8) | (crc_result >> 8)) ; //Exchange CRC16 check sum and bytes at higher and lower orders
}
```

7. Case Study of Modbus Communication Control

Start No.1 inverter to perform forward rotation, and set the rotation velocity to 50.00Hz (indicating 5,000 internally) as per the following commands:

	Address	Function code	Register Address	Number	Bytes	Register Contents	Check Sum
Request	0x01	0x10	0x8000	0x0002	0x04	0x0001, 0x1388	0xCEFF
Response	0x01	0x10	0x8000	0x0004	None	None	0xE80A

Read the operating frequency of No.1 inverter and the response operating frequency of the inverter is 50.00Hz:

	Address	Function code	Register Address	Number	Bytes	Register Contents

Request	0x01	0x03	0x8136	0x0001	None	0x4C38
Response	0x01	0x03	None	0x02	0x1388	0xB512
No.1 inverter stops in the default mode:						
	Address	Function code	Register Address	Register Contents		Check Sum
Request	0x01	0x06	0x8000	0x0000		0xA00A
Response	0x01	0x06	0x8000	0x0000		0xA00A

Note:

It needs to set P0.06 to 2 firstly.

8. Communication Network Construction

- ◆ Connecting one inverter to the computer

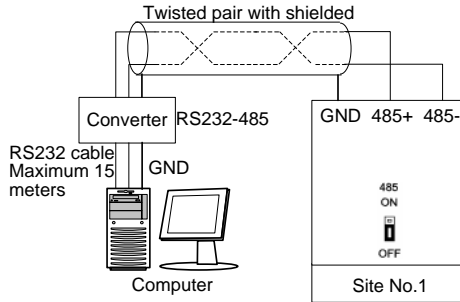

Attached Fig.3 Connecting One Inverter to the Computer

- ◆ Connecting multiple inverters to the computer

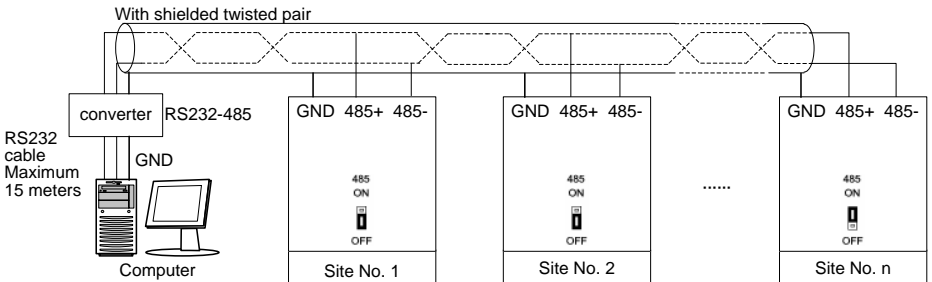

The switch of terminal resistor of the inverter at the most distant place should turn to ON, start, the internal 100Ω terminal compatible resistance

Attached Fig.4 Connecting Multiple Inverters to the Computer

Appendix B Control Mode Setting Process

1. Setting Process for Auto-tuning

Parameter auto-tuning under Vector control 1

Parameter auto-tuning under vector control 2

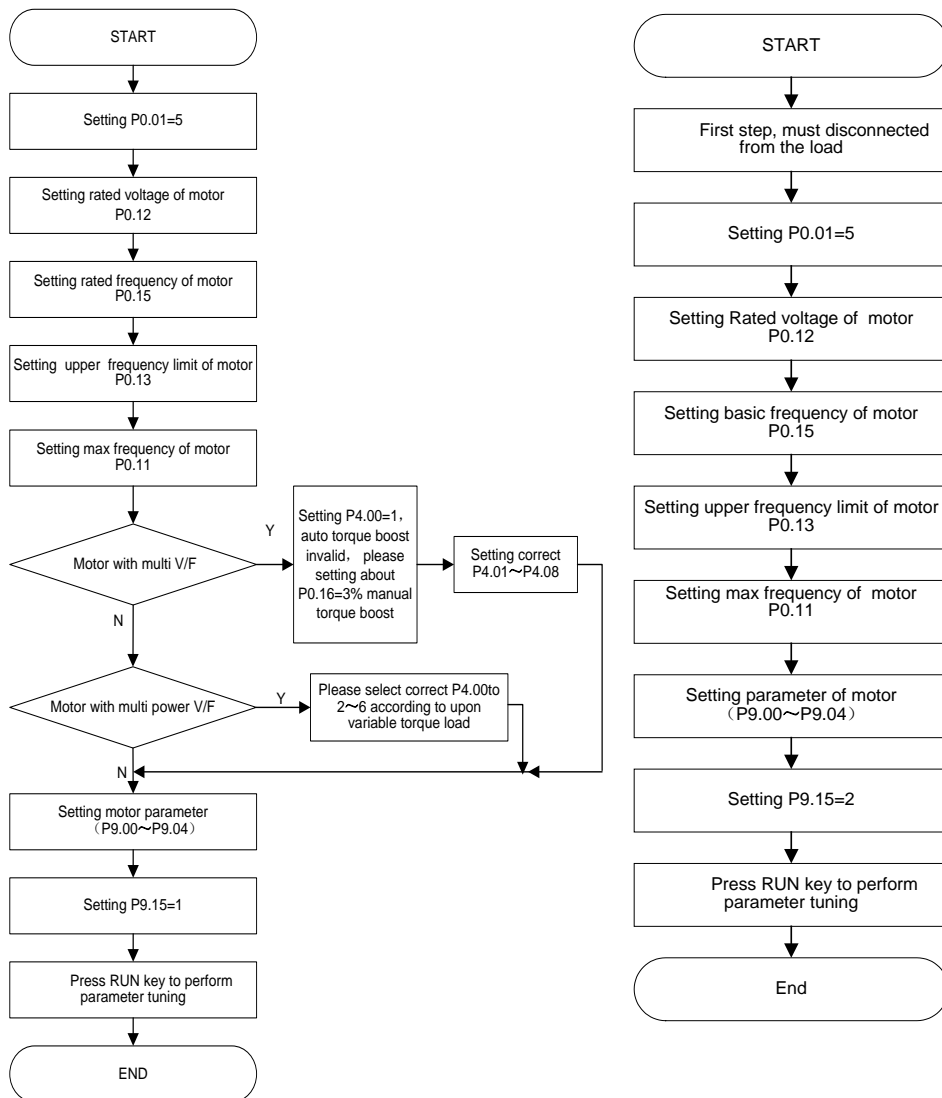

2. Setting Process for Open Loop

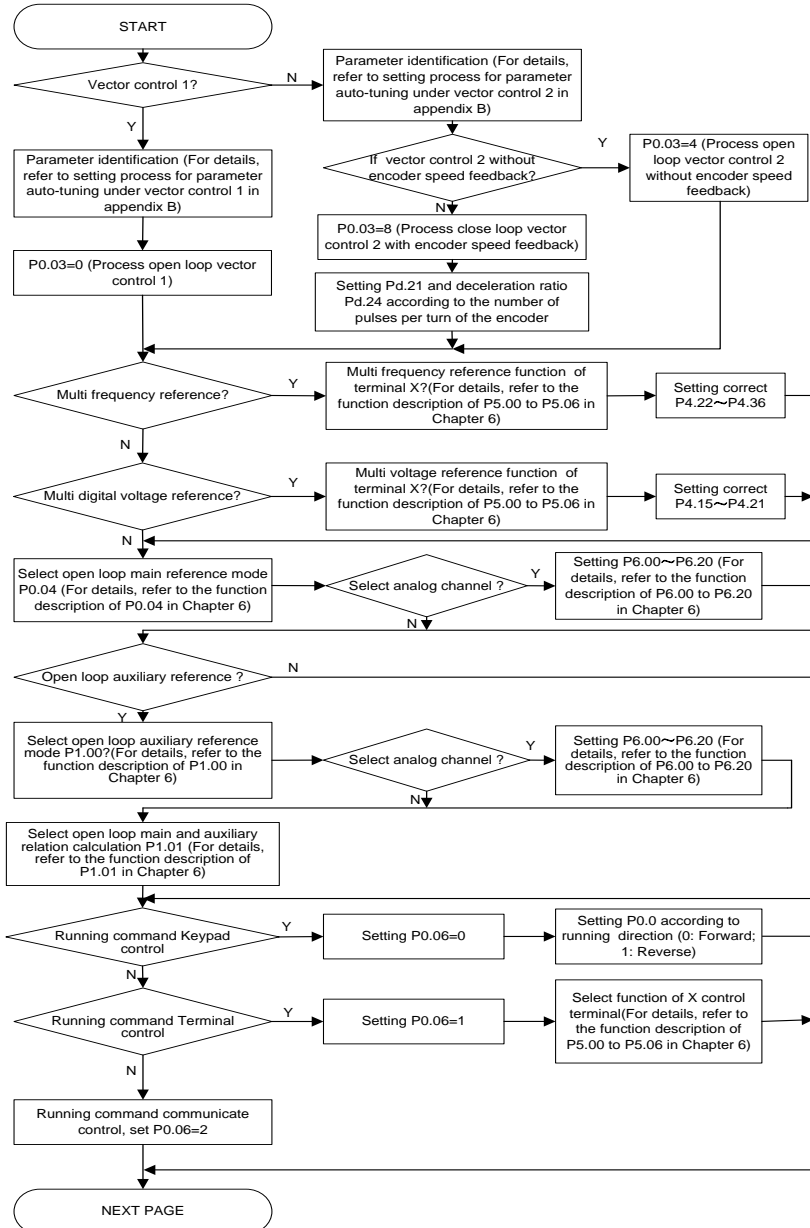

Open loop setting process (continued)

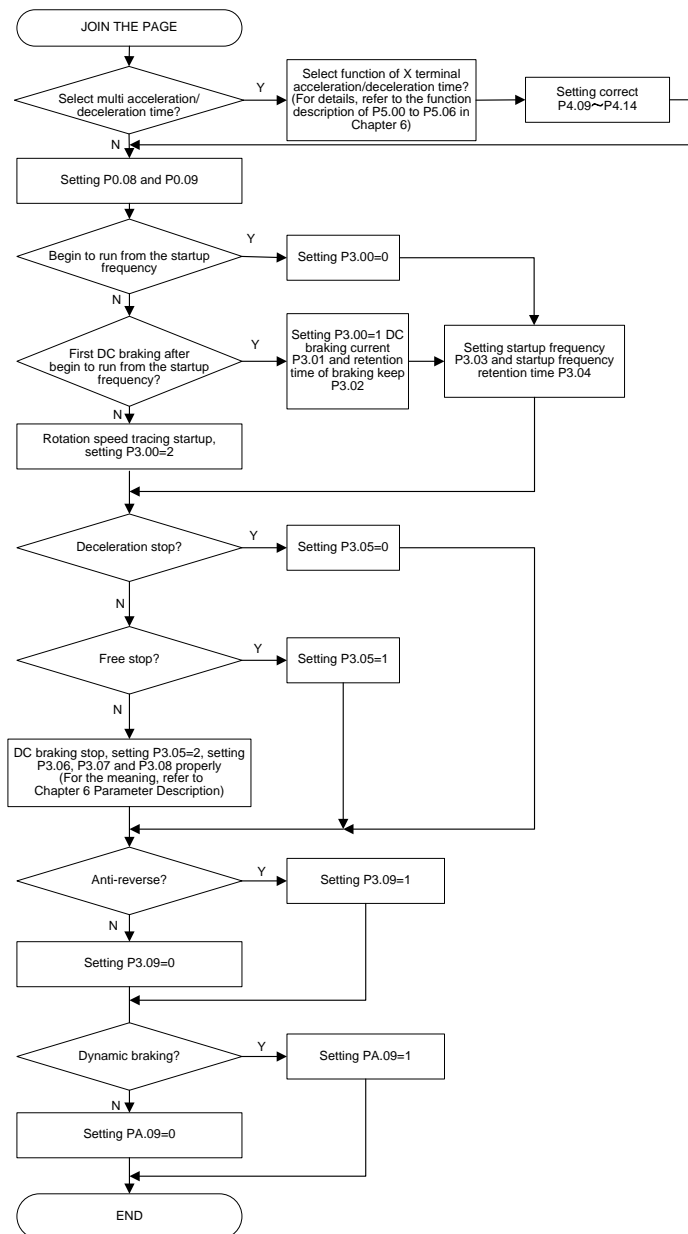

3. Setting Process for Closed Loop

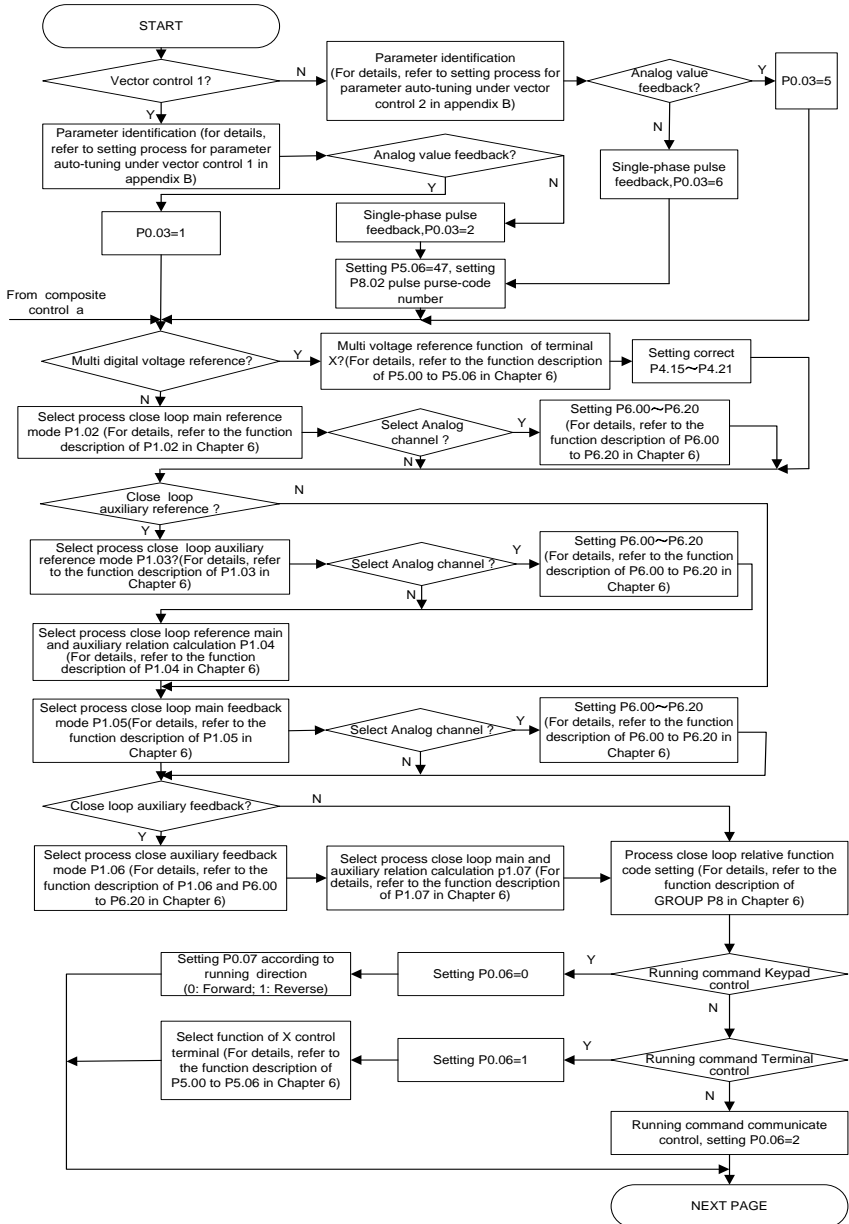

Closed loop setting process (continued)

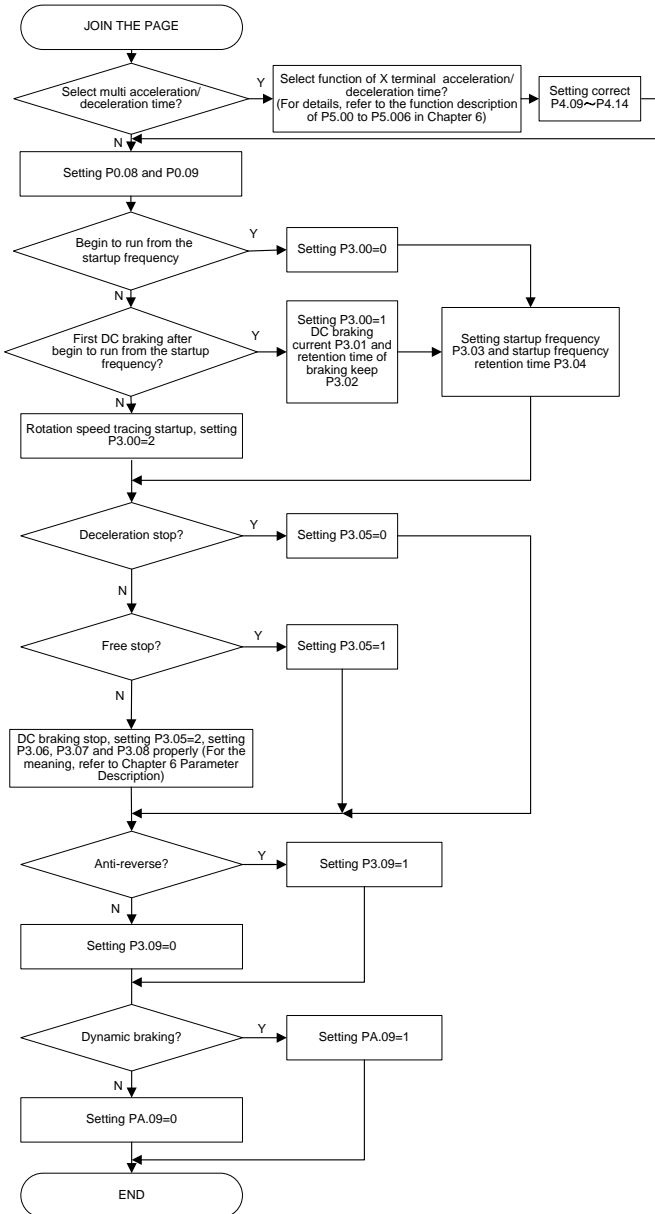

4. Setting Process for Torque Control

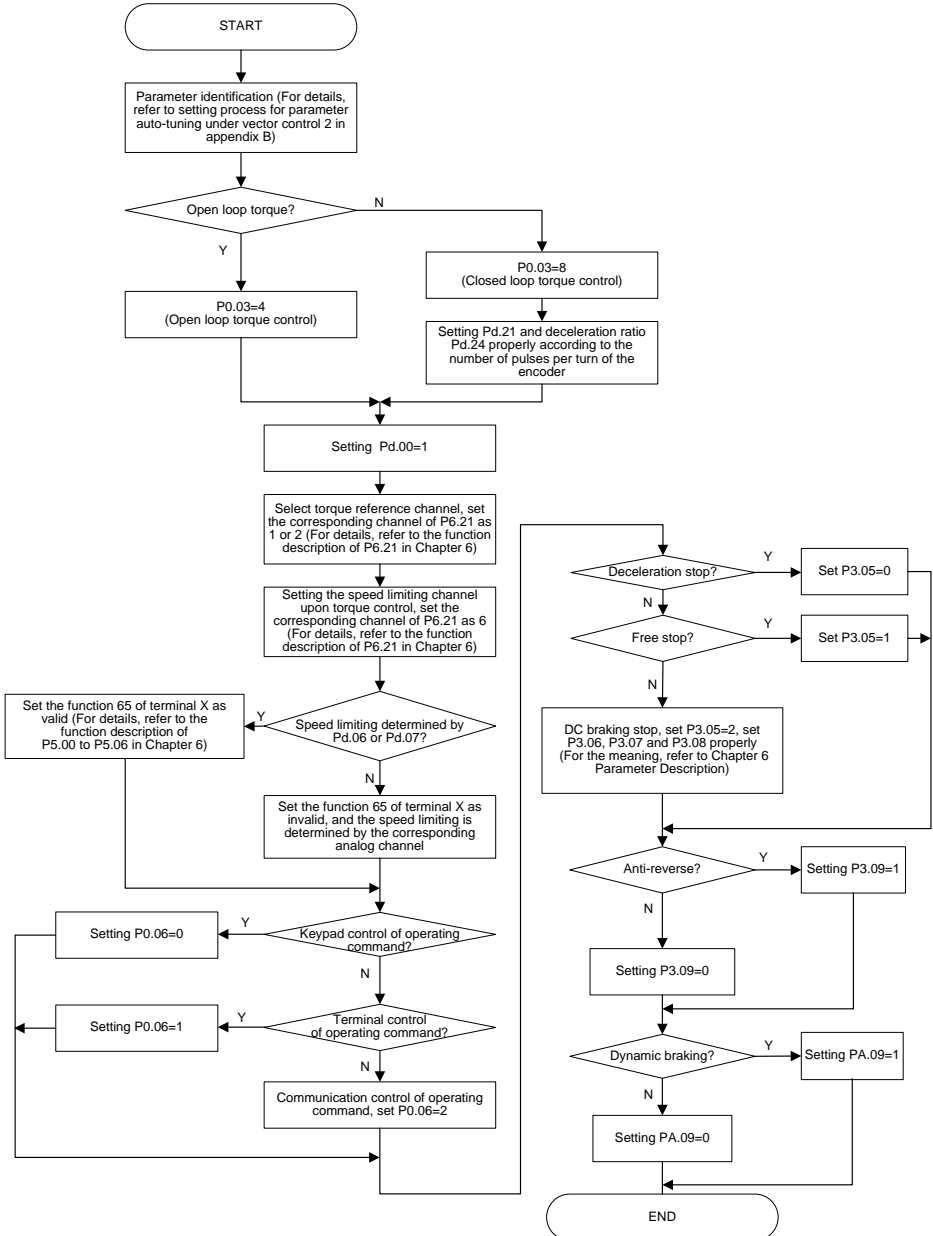

5. Setting Process for Composite Control

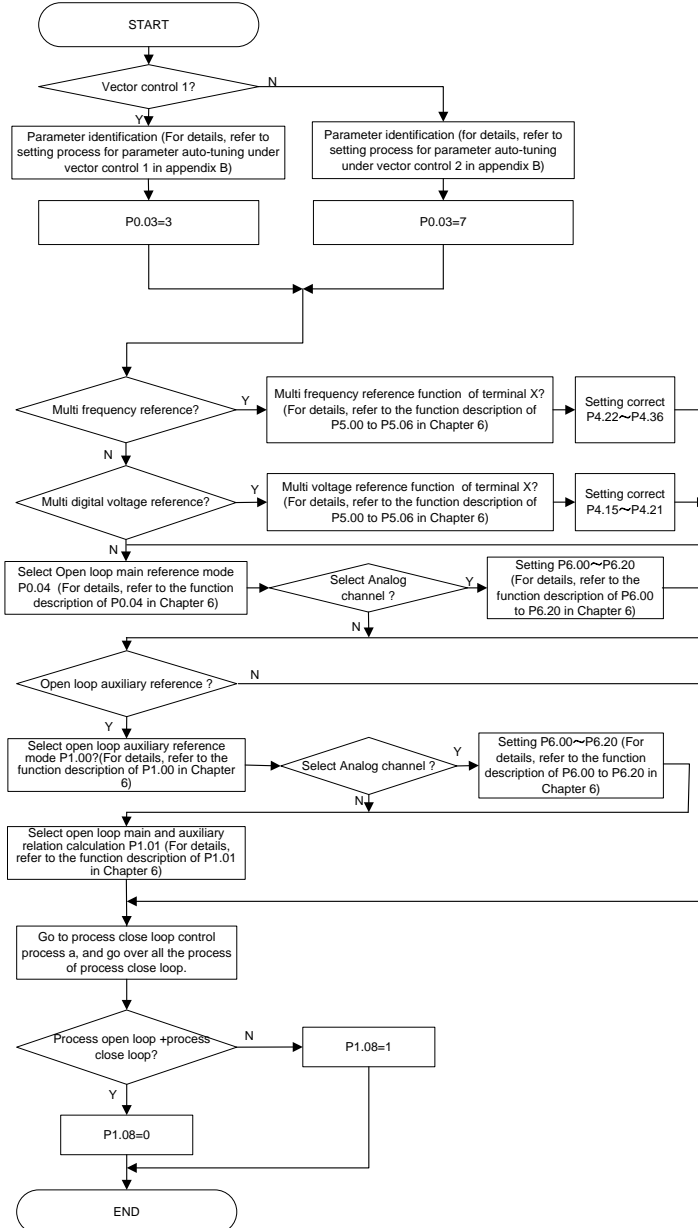

Appendix C FAQ

I. In the case of vector control 2 with encoder speed feedback or torque control, why did the inverter have too large running current or report E.oL1 error?

A: Check the software setup:

A: (1) Check if the motor parameters are properly set;

A: (2) Check if the number of pulses per turn of the encoder Pd.21 is properly set;

A: (3) Check if the deceleration ratio between motor and encoder Pd.24 is properly set;

A: (4) If the above three parameters are properly set, change the value of Pd.22. If it is 0, change it to 1; while if it is 1, change it to 0.

Check the hardware connection:

A: (1) Check if the PG card matches the encoder;

A: (2) Check if the PG card and the encoder are properly connected, check if there is any loose connection or broken wire;

A: (3) Check if the connectors of the PG card and inverter control board are loose or dislocated;

A: (4) Check if the control lines for the V6H-4T18.5G/22L and current sensor of above power class are loose or dislocated.

II. Why did the inverter have abnormal operation upon vector control 2 without encoder speed feedback?

A: (1) Check if there exists large difference between the power class of the motor and that of the inverter;

A: (2) Check if parameter auto-tuning has been performed under vector control 2. For details, refer to the setting process for parameter auto-tuning in Appendix B.

A: (3) Check if the control lines for the V6H-4T18.5G/22L or current sensor of above power class are loose or dislocated.

III. Why did the inverter have abnormal operation upon vector control 2 without encoder speed feedback or vector control 2 with encoder speed feedback?

A: (1) Check if there exists large difference between the power class of the motor and the inverter;

A: (2) Check if parameter auto-tuning has been performed under vector control 2. For details, refer to the setting process for parameter auto-tuning in Appendix B.

A: (3) Check if the torque reference channel and speed limiting channel are properly set. For details, refer to setting process for torque control in Appendix B.

A: (4) Check if the control lines for the V6H-4T18.5G/22L or current sensor of above power class are loose or dislocated.

IV. Why did the inverter have abnormal operation upon vector control 1?

A: (1) Check if parameter auto-tuning has been performed under vector control 1. For details, refer to the setting process for parameter auto-tuning in Appendix B.

A: (2) Check if the control lines for the V6-H-4T18.5G/22L or current sensor of above power class are loose or dislocated.

V. Why was the operating frequency of the inverter kept at 0Hz upon reverse operation?

A: (1) Check if the frequency is set as 0;

A: (2) Check if the inverter function code parameter P3.09 is set as 0. If not, change it to 0.

VI. The inverter had been connected with braking resistor featuring dynamic braking, why didn't it work?

A: (1) Check if the braking resistor is connected between the main circuit terminals B1 and B2;

A: (2) Check if the inverter function code parameter PA.09 is set as 1. If not, change it to 1.

VII. Why was there large deviation on the correspondence relation between the analog input and the setting frequency?

A: (1) Check if the jumpers of analog input type and control board are properly set. For the analog voltage input, toggle the corresponding channel to the V end of the jumper; for the analog current input, toggle the corresponding channel to the I end of the jumper.

A: (2) Calibrate the analog input curve according to function codes P6.00 to P6.2. For details, refer to the description of P6 group in Chapter 6 Parameter Description.

VIII. Why was there large deviation on the correspondence relation between the analog output and the relevant function output?

A: (1) Check if the jumpers of analog output type and control board are properly set. For the analog voltage output, toggle the corresponding channel to the V end of the jumper; for the analog current output, toggle the corresponding channel to the I end of the jumper.

A: (2) Calibrate the analog output curve according to function codes P7.05 to P7.09. For details, refer to the description of P7 group in Chapter 6 Parameter Description.

IX. Why did the inverter report E.AIF analog input abnormal error?

A: (1) Check if the jumpers of analog input type and control board are properly set. For the analog voltage input, toggle the corresponding channel to the V end of the jumper; for the analog current input, toggle the corresponding channel to the I end of the jumper.

A: (2) Check if the analog input exceeds 11V;

A: (3) When using the +10V power supply of the inverter control board, check if the voltage of +10V is lower than 9V or higher than 11V. If yes, check if the resistance value between the +10V and the GND is less than 1K Ω after the inverter is powered off completely.

X. Why did the inverter report E.P10 abnormal error?

A: Check if the voltage of +10V on the inverter control board is lower than 9V or higher than 11V. If yes, check if the resistance value between the +10V and the GND is less than 1K Ω after the inverter is powered off completely.

XI. Why did the PLC and inverter have abnormal 485-based communication?

- A: (1) Check if the data format, address and baud rate of the inverter are consistent with that of the PLC;
- A: (2) Check if the PLC address needs add 1 operation;
- A: (3) Check if the PLC adopts Modbus RTU format;
- A: (4) Check if the register address of the PLC is converted to hexadecimal format;
- (5) Check if the 485 wires are properly connected.

XII. Why did there exist abnormality upon parameter copying?

- A: (1) The parameters for V5 inverter and V6 inverter cannot be copied between each other;
- A: (2) The copy operation can be performed only when the upload and download function codes of the inverter d1.09 (operation panel copy identification code) are consistent;
- A: (3) The copy function can be completed only when the inverter is completely powered down and then powered up after the download of the parameters for copy is completed.

XIII. Why did the keyboard will have “8.8.8.8” display or have no display sometimes?

- A: (1) Check if the connectors are properly connected when the operation panel is directly connected to the inverter control board;
- A: (2) Check if the connection wire signals are in one to one correspondence when the keyboard is connected to the operation panel and inverter control board through customized extension wires;
- A: (3) Check if the network cable connectors of the operation panel and inverter control board are properly connected when standard network cable is used to connect the operation panel and inverter control board.

XIV. Why couldn't display or modify the function codes of the operation panel?

- A: (1) When the modification could not be performed, check if P0.01 is set as 1. If not, change it to 0.
- A: (2) When the modification could not be performed, check if the function code has been set as modification disabled;
- A: (3) When the modification could not be performed upon running, check if the function code could not modification upon running;
- A: (4) When display is not available, check if the inverter function code has been encrypted;
- A: (5) When display is not available, check if the inverter operation panel has been locked;

XV. How could the motor keep the locking force in static status?

- A: (1) Adopt zero-speed running mode upon vector control 2 with encoder speed feedback;
- A: (2) Enable the inverter zero-servo function.

XVI. How to change the direction that the inverter drives the motor to rotate?

- A: (1) In the case of operation panel control, the direction is determined by P0.07. However, the FWD/REV key on the operation panel can real time change the direction.
- A: (2) In the case of operation panel control, the direction is determined by P0.07. However, the UP/DN key on the operation panel (or the FWD/REV knob of the shuttle operation panel) can real time change the

direction.

A: (3) In the case of operation panel control, the positive/negative frequency value resulting from the final frequency calculation for composite control can also change the direction in real time.

A: (4) In the case of terminal control, check if the forward/reverse terminal is in one to one correspondence with that of the control equipment (e.g. PLC).

XVII. Why did the fans of inverters of certain power classes will rotate upon power up, while others could not?

A: The fans of the 15KW inverters and inverters of lower power class are under no control, and they will run when powered up. The operation of the fans of 18.5KW inverters and inverters of higher power class is controlled by the heatsink temperature. When the inverter is powered up under low temperature condition, the fans will not run.

XVIII. What will happen if the CN1 busbar of the control board is loose or damaged?

A: If the CN1 busbar of the control board is loose or damaged, the inverter cannot run or will report several errors. For instance, the inverter may display “-LU- ” or “relay/contacter could not pull on “, or report such errors as E.oc1, E.FAL, E.oH1, E.oH2, E.Cur and E.dL3.

Appendix D PG Card Lectotype and Connection Diagram

1. Option Introduction

Model	Frequency dividing	Technical specification	Power voltage of encoder
EX-PG01	No	Maximum load 200mA, up to 80K pulse input	+12V~+24V
EX-PG02	No	Maximum load 150mA, up to 300K pulse input	+5V
EX-PG03	Yes	Maximum load 200mA, up to 80K pulse input	+12V~+24V
EX-PG04	Yes	Maximum load 150mA, up to 300K pulse input	+5V

2. Frequency Division Number Setting of PG Card

No.1 toggle switch corresponds to bit 0 of binary system;

No.2 toggle switch corresponds to bit 1 of binary system;

No.3 toggle switch corresponds to bit 2 of binary system;

.....

No.8 toggle switch corresponds to bit 7 of binary system;

When the toggle switch is in ON status, the value of the corresponding bit is 1; otherwise, it is 0.

Therefore, frequency division from 1, 2 to 510 can be realized through toggle switch.

In this way, the calculation formula of the number of the PG card frequency divisions is:

Number of frequency divisions= binary number indicated by toggle switch $\times 2$

When the toggle switch is in the status shown in the right figure, the corresponding number of frequency division is 1



When the toggle switch is in the status shown in the figure, the corresponding number of frequency divisions is 2.



When the toggle switch is in the status shown in the figure, the corresponding number of frequency divisions is 510.



3. PG Card Lectotype and Connection Diagram

◆ EX-PG01 Card and EX-PG03 Card

For the open collector, voltage, push-pull (complementary) type motor speed feedback encoder whose power supply is +12V to +24V, please adopt the V&T PG feedback card EX-PG01. If the inverter needs to transmit the motor rotation speed to other equipment for calculation or speed measurement in addition to vector control 2 with encoder speed feedback, please adopt the V&T feedback frequency division output card EX-PG03.

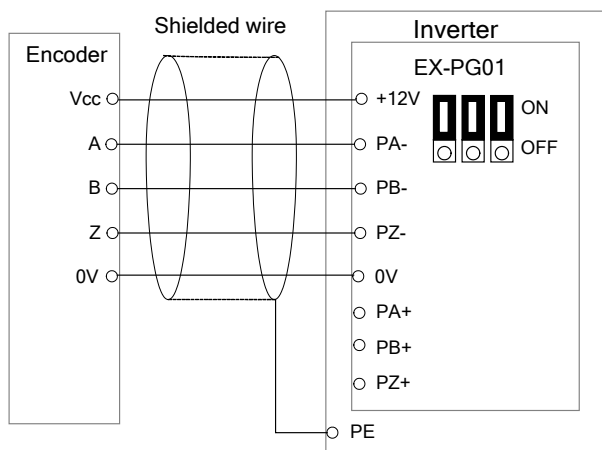

Connection diagram for EX-PG01 card adopting internal power supply

(Jumper toggled to ON side)

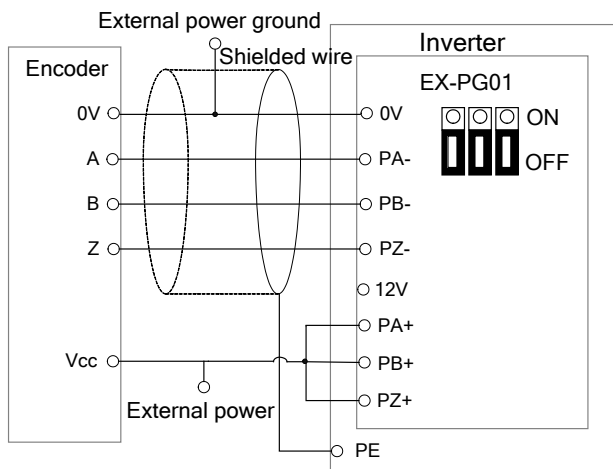

Connection diagram for EX-PG01 card adopting external power supply
(Jumper toggled to OFF side)

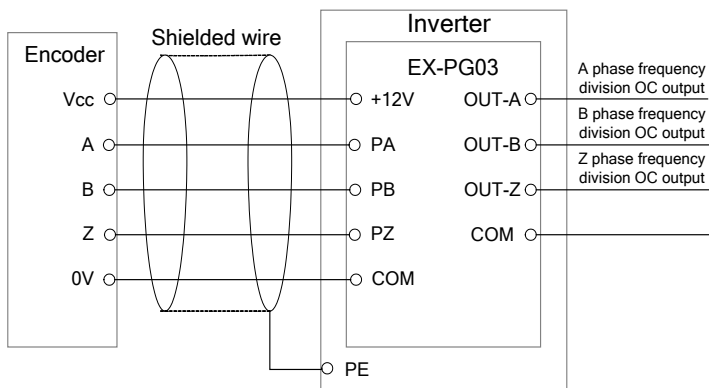

Connection diagram of EX-PG03 card (Does not support external power supply)

◆ EX-PG02 Card and EX-PG04 Card

For the differential motor speed feedback encoder whose power supply is +5V, please adopt the V&T PG feedback card EX-PG02. If the inverter needs to transmit the motor rotation speed to other equipment for calculation or speed measurement in addition to vector control 2 with encoder speed feedback, please

adopt the V&T feedback frequency division output card EX-PG04.

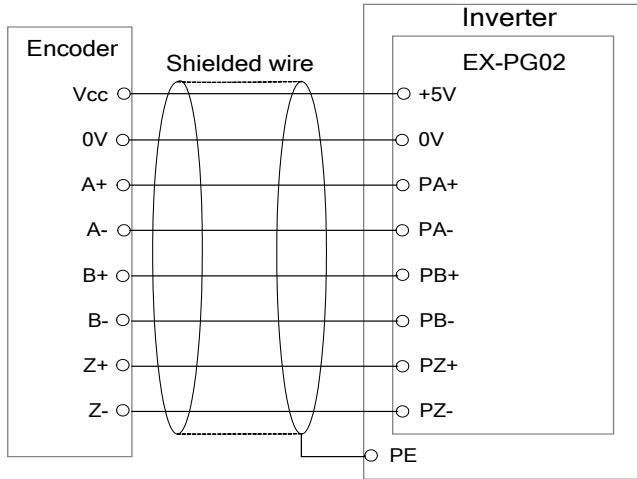

Connection diagram for EX-PG02 card adopting internal power supply

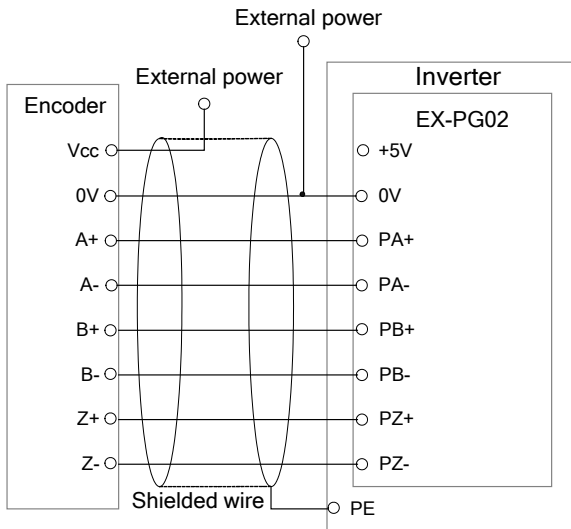

Connection diagram for EX-PG02 card adopting external power supply

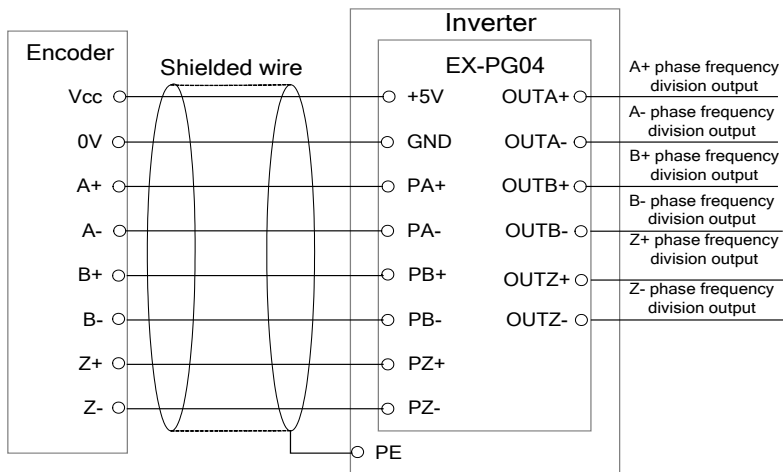

Connection diagram for EX-PG04 card adopting internal power supply

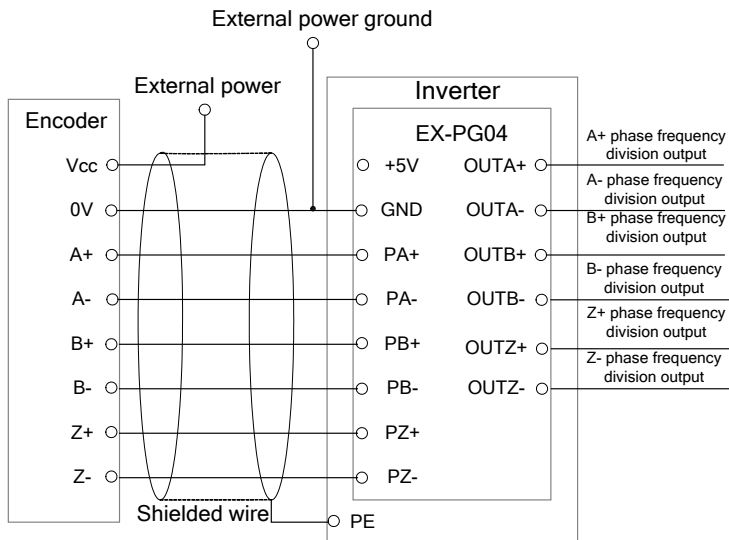

Connection diagram for EX-PG04 card adopting external power supply